



# Standard Test Methods for Tension Testing of Metallic Materials<sup>1</sup>

This standard is issued under the fixed designation E8/E8M; the number immediately following the designation indicates the year of original adoption or, in the case of revision, the year of last revision. A number in parentheses indicates the year of last reapproval. A superscript epsilon ( $\epsilon$ ) indicates an editorial change since the last revision or reapproval.

*This standard has been approved for use by agencies of the U.S. Department of Defense.*

## 1. Scope\*

1.1 These test methods cover the tension testing of metallic materials in any form at room temperature, specifically, the methods of determination of yield strength, yield point elongation, tensile strength, elongation, and reduction of area.

1.2 The gauge lengths for most round specimens are required to be 4D for E8 and 5D for E8M. The gauge length is the most significant difference between E8 and E8M test specimens. Test specimens made from powder metallurgy (P/M) materials are exempt from this requirement by industry-wide agreement to keep the pressing of the material to a specific projected area and density.

1.3 Exceptions to the provisions of these test methods may need to be made in individual specifications or test methods for a particular material. For examples, see Test Methods and Definitions [A370](#) and Test Methods [B557](#), and [B557M](#).

1.4 Room temperature shall be considered to be 10 to 38°C [50 to 100°F] unless otherwise specified.

1.5 The values stated in SI units are to be regarded as separate from inch/pound units. The values stated in each system are not exact equivalents; therefore each system must be used independently of the other. Combining values from the two systems may result in non-conformance with the standard.

1.6 *This standard does not purport to address all of the safety concerns, if any, associated with its use. It is the responsibility of the user of this standard to establish appropriate safety and health practices and determine the applicability of regulatory limitations prior to use.*

<sup>1</sup> These test methods are under the jurisdiction of ASTM Committee [E28](#) on Mechanical Testing and are the direct responsibility of Subcommittee [E28.04](#) on Uniaxial Testing.

Current edition approved May 1, 2015. Published June 2015. Originally approved in 1924. Last previous edition approved 2015 as E8/E8M – 15. DOI: 10.1520/E0008\_E0008M-15A.

## 2. Referenced Documents

### 2.1 ASTM Standards:<sup>2</sup>

- [A356/A356M](#) Specification for Steel Castings, Carbon, Low Alloy, and Stainless Steel, Heavy-Walled for Steam Turbines
- [A370](#) Test Methods and Definitions for Mechanical Testing of Steel Products
- [B557](#) Test Methods for Tension Testing Wrought and Cast Aluminum- and Magnesium-Alloy Products
- [B557M](#) Test Methods for Tension Testing Wrought and Cast Aluminum- and Magnesium-Alloy Products (Metric)
- [E4](#) Practices for Force Verification of Testing Machines
- [E6](#) Terminology Relating to Methods of Mechanical Testing
- [E29](#) Practice for Using Significant Digits in Test Data to Determine Conformance with Specifications
- [E83](#) Practice for Verification and Classification of Extensometer Systems
- [E345](#) Test Methods of Tension Testing of Metallic Foil
- [E691](#) Practice for Conducting an Interlaboratory Study to Determine the Precision of a Test Method
- [E1012](#) Practice for Verification of Testing Frame and Specimen Alignment Under Tensile and Compressive Axial Force Application
- [D1566](#) Terminology Relating to Rubber
- [E1856](#) Guide for Evaluating Computerized Data Acquisition Systems Used to Acquire Data from Universal Testing Machines

## 3. Terminology

### 3.1 Definitions of Terms Common to Mechanical Testing—

3.1.1 The definitions of mechanical testing terms that appear in the Terminology [E6](#) apply to this test method.

<sup>2</sup> For referenced ASTM standards, visit the ASTM website, [www.astm.org](http://www.astm.org), or contact ASTM Customer Service at [service@astm.org](mailto:service@astm.org). For *Annual Book of ASTM Standards* volume information, refer to the standard's Document Summary page on the ASTM website.

\*A Summary of Changes section appears at the end of this standard

3.1.1.1 These terms include bending strain, constraint, elongation, extensometer, force, gauge length, necking, reduced section, stress-strain diagram, testing machine, and modulus of elasticity.

3.1.2 In addition, the following common terms from Terminology E6 are defined:

3.1.3 *discontinuous yielding, n—in a uniaxial test*, a hesitation or fluctuation of force observed at the onset of plastic deformation, due to localized yielding.

3.1.3.1 *Discussion*—The stress-strain curve need not appear to be discontinuous.

3.1.4 *elongation after fracture, n*—the elongation measured by fitting the two halves of the broken specimen together.

3.1.5 *elongation at fracture, n*—the elongation measured just prior to the sudden decrease in force associated with fracture.

3.1.6 *lower yield strength, LYS [FL<sup>-2</sup>]*—in a uniaxial test, the minimum stress recorded during discontinuous yielding, ignoring transient effects.

3.1.7 *reduction of area, n*—the difference between the original cross-sectional area of a tension test specimen and the area of its smallest cross section.

3.1.7.1 *Discussion*—The reduction of area is usually expressed as a percentage of the original cross-sectional area of the specimen.

3.1.7.2 *Discussion*—The smallest cross section may be measured at or after fracture as specified for the material under test.

3.1.7.3 *Discussion*—The term reduction of area when applied to metals generally means measurement after fracture; when applied to plastics and elastomers, measurement at fracture. Such interpretation is usually applicable to values for reduction of area reported in the literature when no further qualification is given. **(E28.04)**

3.1.8 *tensile strength, S<sub>u</sub> [FL<sup>-2</sup>]*, *n*—the maximum tensile stress that a material is capable of sustaining.

3.1.8.1 *Discussion*—Tensile strength is calculated from the maximum force during a tension test carried to rupture and the original cross-sectional area of the specimen.

3.1.9 *uniform elongation, El<sub>w</sub> [%]*—the elongation determined at the maximum force sustained by the test piece just prior to necking or fracture, or both.

3.1.9.1 *Discussion*—Uniform elongation includes both elastic and plastic elongation.

3.1.10 *upper yield strength, UYS [FL<sup>-2</sup>]*—in a uniaxial test, the first stress maximum (stress at first zero slope) associated with discontinuous yielding at or near the onset of plastic deformation.

3.1.11 *yield point elongation, YPE, n—in a uniaxial test*, the strain (expressed in percent) separating the stress-strain curve's first point of zero slope from the point of transition from discontinuous yielding to uniform strain hardening.

3.1.11.1 *Discussion*— If the transition occurs over a range of strain, the YPE end point is the intersection between (a) a horizontal line drawn tangent to the curve at the last zero slope and (b) a line drawn tangent to the strain hardening portion of the stress-strain curve at the point of inflection. If there is no

point at or near the onset of yielding at which the slope reaches zero, the material has 0 % YPE.

3.1.12 *yield strength, YS or S<sub>y</sub> [FL<sup>-2</sup>]*, *n*—the engineering stress at which, by convention, it is considered that plastic elongation of the material has commenced.

3.1.12.1 *Discussion*—This stress may be specified in terms of (a) a specified deviation from a linear stress-strain relationship, (b) a specified total extension attained, or (c) maximum or minimum engineering stresses measured during discontinuous yielding.

### 3.2 Definitions of Terms Specific to This Standard:

3.2.1 *referee test, n*—test made to settle a disagreement as to the conformance to specified requirements, or conducted by a third party to arbitrate between conflicting results. **D1566, D11.08**

## 4. Significance and Use

4.1 Tension tests provide information on the strength and ductility of materials under uniaxial tensile stresses. This information may be useful in comparisons of materials, alloy development, quality control, and design under certain circumstances.

4.2 The results of tension tests of specimens machined to standardized dimensions from selected portions of a part or material may not totally represent the strength and ductility properties of the entire end product or its in-service behavior in different environments.

4.3 These test methods are considered satisfactory for acceptance testing of commercial shipments. The test methods have been used extensively in the trade for this purpose.

## 5. Apparatus

5.1 *Testing Machines*—Machines used for tension testing shall conform to the requirements of Practices E4. The forces used in determining tensile strength and yield strength shall be within the verified force application range of the testing machine as defined in Practices E4.

### 5.2 Gripping Devices:

5.2.1 *General*—Various types of gripping devices may be used to transmit the measured force applied by the testing machine to the test specimens. To ensure axial tensile stress within the gauge length, the axis of the test specimen should coincide with the center line of the heads of the testing machine. Any departure from this requirement may introduce bending stresses that are not included in the usual stress computation (force divided by cross-sectional area).

NOTE 1—The effect of this eccentric force application may be illustrated by calculating the bending moment and stress thus added. For a standard 12.5-mm [0.500-in.] diameter specimen, the stress increase is 1.5 percentage points for each 0.025 mm [0.001 in.] of eccentricity. This error increases to 2.5 percentage points/0.025 mm [0.001 in.] for a 9 mm [0.350-in.] diameter specimen and to 3.2 percentage points/0.025 mm [0.001 in.] for a 6-mm [0.250-in.] diameter specimen.

NOTE 2—Alignment methods are given in Practice E1012.

5.2.2 *Wedge Grips*—Testing machines usually are equipped with wedge grips. These wedge grips generally furnish a satisfactory means of gripping long specimens of ductile metal

and flat plate test specimens such as those shown in Fig. 1. If, however, for any reason, one grip of a pair advances farther than the other as the grips tighten, an undesirable bending stress may be introduced. When liners are used behind the wedges, they must be of the same thickness and their faces must be flat and parallel. For best results, the wedges should be supported over their entire lengths by the heads of the testing machine. This requires that liners of several thicknesses be available to cover the range of specimen thickness. For proper gripping, it is desirable that the entire length of the serrated face of each wedge be in contact with the specimen. Proper alignment of wedge grips and liners is illustrated in Fig. 2. For short specimens and for specimens of many materials it is generally necessary to use machined test specimens and to use a special means of gripping to ensure that the specimens, when under load, shall be as nearly as possible in uniformly distributed pure axial tension (see 5.2.3, 5.2.4, and 5.2.5).

**5.2.3 Grips for Threaded and Shouldered Specimens and Brittle Materials**—A schematic diagram of a gripping device for threaded-end specimens is shown in Fig. 3, while Fig. 4 shows a device for gripping specimens with shouldered ends. Both of these gripping devices should be attached to the heads of the testing machine through properly lubricated spherical-seated bearings. The distance between spherical bearings should be as great as feasible.

**5.2.4 Grips for Sheet Materials**—The self-adjusting grips shown in Fig. 5 have proven satisfactory for testing sheet materials that cannot be tested satisfactorily in the usual type of wedge grips.

**5.2.5 Grips for Wire**—Grips of either the wedge or snubbing types as shown in Fig. 5 and Fig. 6 or flat wedge grips may be used.

**5.3 Dimension-Measuring Devices**—Micrometers and other devices used for measuring linear dimensions shall be accurate and precise to at least one half the smallest unit to which the individual dimension is required to be measured.

**5.4 Extensometers**—Extensometers used in tension testing shall conform to the requirements of Practice E83 for the classifications specified by the procedure section of this test method. Extensometers shall be used and verified to include the strains corresponding to the yield strength and elongation at fracture (if determined).

**5.4.1** Extensometers with gauge lengths equal to or shorter than the nominal gauge length of the specimen (dimension shown as “G-Gauge Length” in the accompanying figures) may be used to determine the yield behavior. For specimens without a reduced section (for example, full cross sectional area specimens of wire, rod, or bar), the extensometer gauge length for the determination of yield behavior shall not exceed 80 % of the distance between grips. For measuring elongation at fracture with an appropriate extensometer, the gauge length of the extensometer shall be equal to the nominal gauge length required for the specimen being tested.

## 6. Test Specimens

### 6.1 General:

**6.1.1 Specimen Size**—Test specimens shall be either substantially full size or machined, as prescribed in the product specifications for the material being tested.

**6.1.2 Location**—Unless otherwise specified, the axis of the test specimen shall be located within the parent material as follows:

**6.1.2.1** At the center for products 40 mm [1.500 in.] or less in thickness, diameter, or distance between flats.

**6.1.2.2** Midway from the center to the surface for products over 40 mm [1.500 in.] in thickness, diameter, or distance between flats.

**6.1.3 Specimen Machining**—Improperly prepared test specimens often are the reason for unsatisfactory and incorrect test results. It is important, therefore, that care be exercised in the preparation of specimens, particularly in the machining, to maximize precision and minimize bias in test results.

**6.1.3.1** The reduced sections of prepared specimens should be free of cold work, notches, chatter marks, grooves, gouges, burrs, rough surfaces or edges, overheating, or any other condition which can deleteriously affect the properties to be measured.

**NOTE 3**—Punching or blanking of the reduced section may produce significant cold work or shear burrs, or both, along the edges which should be removed by machining.

**6.1.3.2** Within the reduced section of rectangular specimens, edges or corners should not be ground or abraded in a manner which could cause the actual cross-sectional area of the specimen to be significantly different from the calculated area.

**6.1.3.3** For brittle materials, large radius fillets at the ends of the gauge length should be used.

**6.1.3.4** The cross-sectional area of the specimen should be smallest at the center of the reduced section to ensure fracture within the gauge length. For this reason, a small taper is permitted in the reduced section of each of the specimens described in the following sections.

**6.1.4 Specimen Surface Finish**—When materials are tested with surface conditions other than as manufactured, the surface finish of the test specimens should be as provided in the applicable product specifications.

**NOTE 4**—Particular attention should be given to the uniformity and quality of surface finish of specimens for high strength and very low ductility materials since this has been shown to be a factor in the variability of test results.

**6.2 Plate-Type Specimens**—The standard plate-type test specimen is shown in Fig. 1. This specimen is used for testing metallic materials in the form of plate, shapes, and flat material having a nominal thickness of 5 mm [0.188 in.] or over. When product specifications so permit, other types of specimens may be used, as provided in 6.3, 6.4, and 6.5.

### 6.3 Sheet-Type Specimens:

**6.3.1** The standard sheet-type test specimen is shown in Fig. 1. This specimen is used for testing metallic materials in the form of sheet, plate, flat wire, strip, band, hoop, rectangles, and shapes ranging in nominal thickness from 0.13 to 19 mm [0.005 to 0.750 in.]. When product specifications so permit, other types of specimens may be used, as provided in 6.2, 6.4, and 6.5.

**E8/E8M – 15a**

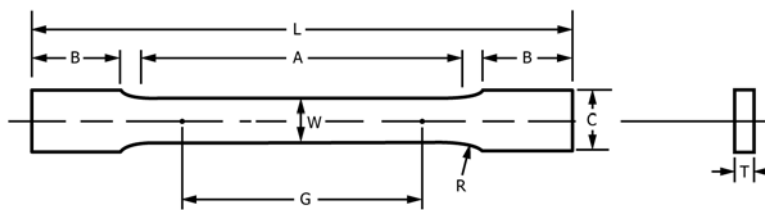

	Dimensions		
	Standard Specimens		Subsize Specimen
	Plate-Type, 40 mm [1.500 in.] Wide	Sheet-Type, 12.5 mm [0.500 in.] Wide	6 mm [0.250 in.] Wide
	mm [in.]	mm [in.]	mm [in.]
<b>G</b> —Gauge length (Note 1 and Note 2)	200.0 ± 0.2 [8.00 ± 0.01]	50.0 ± 0.1 [2.000 ± 0.005]	25.0 ± 0.1 [1.000 ± 0.003]
<b>W</b> —Width (Note 3 and Note 4)	40.0 ± 2.0 [1.500 ± 0.125, -0.250]	12.5 ± 0.2 [0.500 ± 0.010]	6.0 ± 0.1 [0.250 ± 0.005]
<b>T</b> —Thickness (Note 5)		thickness of material	
<b>R</b> —Radius of fillet, min (Note 6)	25 [1]	12.5 [0.500]	6 [0.250]
<b>L</b> —Overall length, min (Note 2, Note 7, and Note 8)	450 [18]	200 [8]	100 [4]
<b>A</b> —Length of reduced section, min	225 [9]	57 [2.25]	32 [1.25]
<b>B</b> —Length of grip section, min (Note 9)	75 [3]	50 [2]	30 [1.25]
<b>C</b> —Width of grip section, approximate (Note 4 and Note 9)	50 [2]	20 [0.750]	10 [0.375]

NOTE 1—For the 40 mm [1.500 in.] wide specimen, punch marks for measuring elongation after fracture shall be made on the flat or on the edge of the specimen and within the reduced section. Either a set of nine or more punch marks 25 mm [1 in.] apart, or one or more pairs of punch marks 200 mm [8 in.] apart may be used.

NOTE 2—When elongation measurements of 40 mm [1.500 in.] wide specimens are not required, a minimum length of reduced section (A) of 75 mm [2.25 in.] may be used with all other dimensions similar to those of the plate-type specimen.

NOTE 3—For the three sizes of specimens, the ends of the reduced section shall not differ in width by more than 0.10, 0.05 or 0.02 mm [0.004, 0.002 or 0.001 in.], respectively. Also, there may be a gradual decrease in width from the ends to the center, but the width at each end shall not be more than 1 % larger than the width at the center.

NOTE 4—For each of the three sizes of specimens, narrower widths (W and C) may be used when necessary. In such cases the width of the reduced section should be as large as the width of the material being tested permits; however, unless stated specifically, the requirements for elongation in a product specification shall not apply when these narrower specimens are used.

NOTE 5—The dimension T is the thickness of the test specimen as provided for in the applicable material specifications. Minimum thickness of 40 mm [1.500 in.] wide specimens shall be 5 mm [0.188 in.]. Maximum thickness of 12.5 and 6 mm [0.500 and 0.250 in.] wide specimens shall be 19 and 6 mm [0.750 and 0.250 in.], respectively.

NOTE 6—For the 40 mm [1.500 in.] wide specimen, a 13 mm [0.500 in.] minimum radius at the ends of the reduced section is permitted for steel specimens under 690 MPa [100 000 psi] in tensile strength when a profile cutter is used to machine the reduced section.

NOTE 7—The dimension shown is suggested as a minimum. In determining the minimum length, the grips must not extend in to the transition section between Dimensions A and B, see Note 9.

NOTE 8—To aid in obtaining axial force application during testing of 6-mm [0.250-in.] wide specimens, the overall length should be as large as the material will permit, up to 200 mm [8.00 in.].

NOTE 9—It is desirable, if possible, to make the length of the grip section large enough to allow the specimen to extend into the grips a distance equal to two thirds or more of the length of the grips. If the thickness of 12.5 mm [0.500-in.] wide specimens is over 10 mm [0.375 in.], longer grips and correspondingly longer grip sections of the specimen may be necessary to prevent failure in the grip section.

NOTE 10—For the three sizes of specimens, the ends of the specimen shall be symmetrical in width with the center line of the reduced section within 2.5, 1.25 and 0.13 mm [0.10, 0.05 and 0.005 in.], respectively. However, for referee testing and when required by product specifications, the ends of the 12.5 mm [0.500 in.] wide specimen shall be symmetrical within 0.2 mm [0.01 in.].

NOTE 11—For each specimen type, the radii of all fillets shall be equal to each other within a tolerance of 1.25 mm [0.05 in.], and the centers of curvature of the two fillets at a particular end shall be located across from each other (on a line perpendicular to the centerline) within a tolerance of 2.5 mm [0.10 in.].

NOTE 12—Specimens with sides parallel throughout their length are permitted, except for referee testing, provided: (a) the above tolerances are used; (b) an adequate number of marks are provided for determination of elongation; and (c) when yield strength is determined, a suitable extensometer is used. If the fracture occurs at a distance of less than 2 W from the edge of the gripping device, the tensile properties determined may not be representative of the material. In acceptance testing, if the properties meet the minimum requirements specified, no further testing is required, but if they are less than the minimum requirements, discard the test and retest.

**FIG. 1 Rectangular Tension Test Specimens**

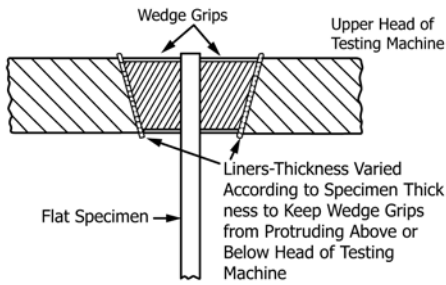

FIG. 2 Wedge Grips with Liners for Flat Specimens

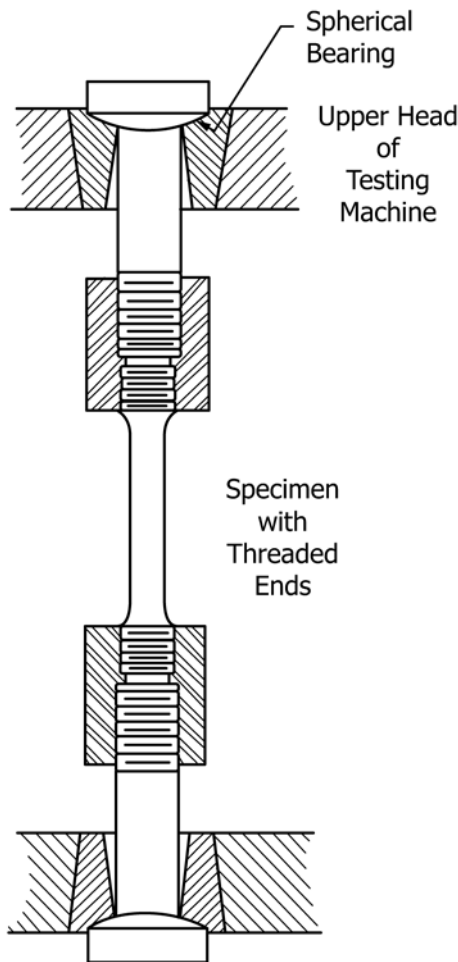

FIG. 3 Gripping Device for Threaded-End Specimens

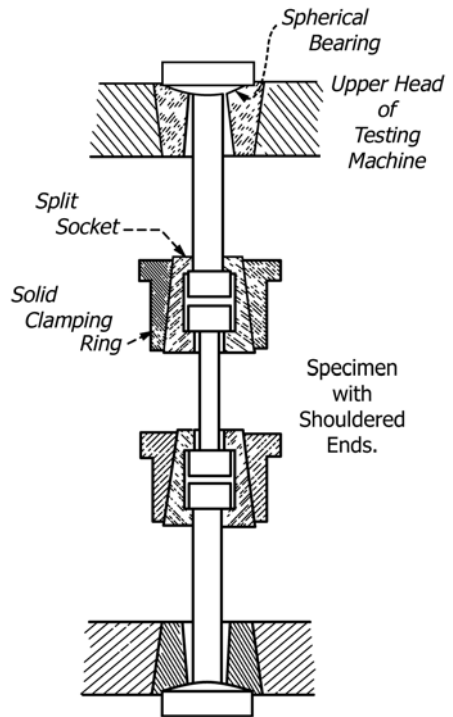

FIG. 4 Gripping Device for Shouldered-End Specimens

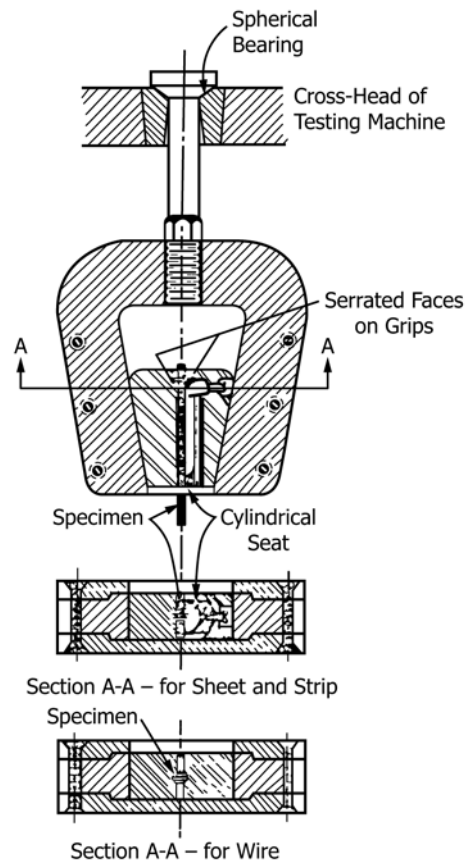

FIG. 5 Gripping Devices for Sheet and Wire Specimens

NOTE 5—Test Methods E345 may be used for tension testing of materials in thicknesses up to 0.15 mm [0.0059 in.].

6.3.2 Pin ends as shown in Fig. 7 may be used. In order to avoid buckling in tests of thin and high-strength materials, it may be necessary to use stiffening plates at the grip ends.

6.4 Round Specimens:

6.4.1 The standard 12.5-mm [0.500-in.] diameter round test specimen shown in Fig. 8 is used quite generally for testing metallic materials, both cast and wrought.

6.4.2 Fig. 8 also shows small-size specimens proportional to the standard specimen. These may be used when it is necessary to test material from which the standard specimen or specimens shown in Fig. 1 cannot be prepared. Other sizes of small round

specimens may be used. In any such small-size specimen it is important that the gauge length for measurement of elongation

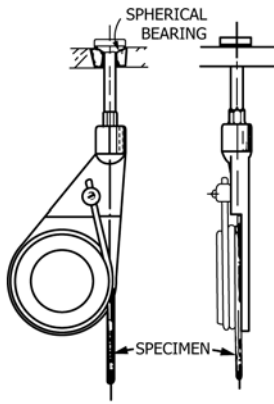

FIG. 6 Snubbing Device for Testing Wire

be four times the diameter of the specimen when following E8 and five times the diameter of the specimen when following E8M.

6.4.3 The shape of the ends of the specimen outside of the gauge length shall be suitable to the material and of a shape to fit the holders or grips of the testing machine so that the forces may be applied axially. Fig. 9 shows specimens with various types of ends that have given satisfactory results.

6.5 *Specimens for Sheet, Strip, Flat Wire, and Plate*—In testing sheet, strip, flat wire, and plate, use a specimen type appropriate for the nominal thickness of the material, as described in the following:

6.5.1 For material with a nominal thickness of 0.13 to 5 mm [0.005 to 0.1875 in.], use the sheet-type specimen described in 6.3.

6.5.2 For material with a nominal thickness of 5 to 12.5 mm [0.1875 to 0.500 in.], use either the sheet-type specimen of 6.3 or the plate-type specimen of 6.2.

6.5.3 For material with a nominal thickness of 12.5 to 19 mm [0.500 to 0.750 in.], use either the sheet-type specimen of 6.3, the plate-type specimen of 6.2, or the largest practical size of round specimen described in 6.4.

6.5.4 For material with a nominal thickness of 19 mm [0.750 in.], or greater, use the plate-type specimen of 6.2 or the largest practical size of round specimen described in 6.4.

6.5.4.1 If the product specifications permit, material of a thickness of 19 mm [0.750 in.], or greater may be tested using a modified sheet-type specimen conforming to the configuration shown by Fig. 1. The thickness of this modified specimen must be machined to  $10 \pm 0.5$  mm [ $0.400 \pm 0.020$  in.], and must be uniform within 0.1 mm [0.004 in.] throughout the reduced section. In the event of disagreement, a round specimen shall be used as the referee test (comparison) specimen.

6.6 *Specimens for Wire, Rod, and Bar:*

6.6.1 For round wire, rod, and bar, test specimens having the full cross-sectional area of the wire, rod, or bar shall be used wherever practicable. The gauge length for the measurement of elongation of wire less than 4 mm [0.125 in.] in diameter shall be as prescribed in product specifications. When testing wire, rod, or bar having a diameter of 4 mm [0.125 in.] or larger, a gauge length equal to four times the diameter shall be used when following E8 and a gauge length equal to five times the

diameter shall be used when following E8M unless otherwise specified. The total length of the specimens shall be at least equal to the gauge length plus the length of material required for the full use of the grips employed.

6.6.2 For wire of octagonal, hexagonal, or square cross section, for rod or bar of round cross section where the specimen required in 6.6.1 is not practicable, and for rod or bar of octagonal, hexagonal, or square cross section, one of the following types of specimens shall be used:

6.6.2.1 *Full Cross Section* (Note 6)—It is permissible to reduce the test section slightly with abrasive cloth or paper, or machine it sufficiently to ensure fracture within the gauge marks. For material not exceeding 5 mm [0.188 in.] in diameter or distance between flats, the cross-sectional area may be reduced to not less than 90 % of the original area without changing the shape of the cross section. For material over 5 mm [0.188 in.] in diameter or distance between flats, the diameter or distance between flats may be reduced by not more than 0.25 mm [0.010 in.] without changing the shape of the cross section. Square, hexagonal, or octagonal wire or rod not exceeding 5 mm [0.188 in.] between flats may be turned to a round having a cross-sectional area not smaller than 90 % of the area of the maximum inscribed circle. Fillets, preferably with a radius of 10 mm [0.375 in.], but not less than 3 mm [0.125 in.], shall be used at the ends of the reduced sections. Square, hexagonal, or octagonal rod over 5 mm [0.188 in.] between flats may be turned to a round having a diameter no smaller than 0.25 mm [0.010 in.] less than the original distance between flats.

NOTE 6—The ends of copper or copper alloy specimens may be flattened 10 to 50 % from the original dimension in a jig similar to that shown in Fig. 10, to facilitate fracture within the gauge marks. In flattening the opposite ends of the test specimen, care shall be taken to ensure that the four flattened surfaces are parallel and that the two parallel surfaces on the same side of the axis of the test specimen lie in the same plane.

6.6.2.2 For rod and bar, the largest practical size of round specimen as described in 6.4 may be used in place of a test specimen of full cross section. Unless otherwise specified in the product specification, specimens shall be parallel to the direction of rolling or extrusion.

6.7 *Specimens for Rectangular Bar*—In testing rectangular bar one of the following types of specimens shall be used:

6.7.1 *Full Cross Section*—It is permissible to reduce the width of the specimen throughout the test section with abrasive cloth or paper, or by machining sufficiently to facilitate fracture within the gauge marks, but in no case shall the reduced width be less than 90 % of the original. The edges of the midlength of the reduced section not less than 20 mm [ $\frac{3}{4}$  in.] in length shall be parallel to each other and to the longitudinal axis of the specimen within 0.05 mm [0.002 in.]. Fillets, preferably with a radius of 10 mm [ $\frac{3}{8}$  in.] but not less than 3 mm [ $\frac{1}{8}$  in.] shall be used at the ends of the reduced sections.

6.7.2 Rectangular bar of thickness small enough to fit the grips of the testing machine but of too great width may be reduced in width by cutting to fit the grips, after which the cut surfaces shall be machined or cut and smoothed to ensure failure within the desired section. The reduced width shall not

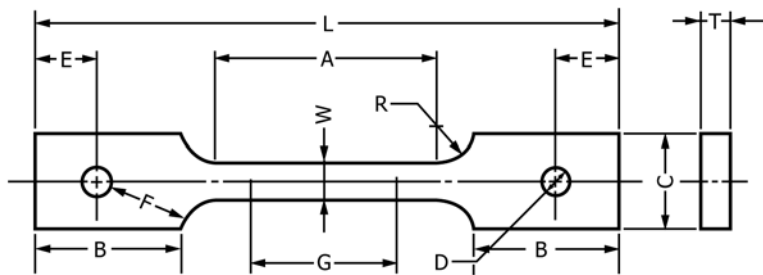

Dimensions, mm [in.]

G—Gauge length	50.0 ± 0.1 [2.000 ± 0.005]
W—Width (Note 1)	12.5 ± 0.2 [0.500 ± 0.010]
T—Thickness, max (Note 2)	16 [0.625]
R—Radius of fillet, min (Note 3)	13 [0.5]
L—Overall length, min	200 [8]
A—Length of reduced section, min	57 [2.25]
B—Length of grip section, min	50 [2]
C—Width of grip section, approximate	50 [2]
D—Diameter of hole for pin, min (Note 4)	13 [0.5]
E—Edge distance from pin, approximate	40 [1.5]
F—Distance from hole to fillet, min	13 [0.5]

NOTE 1—The ends of the reduced section shall differ in width by not more than 0.1 mm [0.002 in.]. There may be a gradual taper in width from the ends to the center, but the width at each end shall be not more than 1 % greater than the width at the center.

NOTE 2—The dimension *T* is the thickness of the test specimen as stated in the applicable product specifications.

NOTE 3—For some materials, a fillet radius *R* larger than 13 mm [0.500 in.] may be needed.

NOTE 4—Holes must be on center line of reduced section within ± 0.05mm [0.002 in.].

NOTE 5—Variations of dimensions *C*, *D*, *E*, *F*, and *L* may be used that will permit failure within the gauge length.

FIG. 7 Pin-Loaded Tension Test Specimen with 50-mm [2-in.] Gauge Length

be less than the original bar thickness. Also, one of the types of specimens described in 6.2, 6.3, and 6.4 may be used.

6.8 *Shapes, Structural and Other*—In testing shapes other than those covered by the preceding sections, one of the types of specimens described in 6.2, 6.3, and 6.4 shall be used.

#### 6.9 *Specimens for Pipe and Tube* (Note 7):

6.9.1 For all small tube (Note 7), particularly sizes 25 mm [1 in.] and under in nominal outside diameter, and frequently for larger sizes, except as limited by the testing equipment, it is standard practice to use tension test specimens of full-size tubular sections. Snug-fitting metal plugs shall be inserted far enough into the ends of such tubular specimens to permit the testing machine jaws to grip the specimens properly. The plugs shall not extend into that part of the specimen on which the elongation is measured. Elongation is measured over a length of four times the diameter when following E8 or five times the diameter when following E8M unless otherwise stated in the product specification. Fig. 11 shows a suitable form of plug, the location of the plugs in the specimen, and the location of the specimen in the grips of the testing machine.

NOTE 7—The term “tube” is used to indicate tubular products in general, and includes pipe, tube, and tubing.

6.9.2 For large-diameter tube that cannot be tested in full section, longitudinal tension test specimens shall be cut as indicated in Fig. 12. Specimens from welded tube shall be located approximately 90° from the weld. If the tube-wall thickness is under 20 mm [0.750 in.], either a specimen of the form and dimensions shown in Fig. 13 or one of the small-size

specimens proportional to the standard 12.5-mm [0.500-in.] specimen, as mentioned in 6.4.2 and shown in Fig. 8, shall be used. Specimens of the type shown in Fig. 13 may be tested with grips having a surface contour corresponding to the curvature of the tube. When grips with curved faces are not available, the ends of the specimens may be flattened without heating. If the tube-wall thickness is 20 mm [0.750 in.] or over, the standard specimen shown in Fig. 8 shall be used.

NOTE 8—In clamping of specimens from pipe and tube (as may be done during machining) or in flattening specimen ends (for gripping), care must be taken so as not to subject the reduced section to any deformation or cold work, as this would alter the mechanical properties.

6.9.3 Transverse tension test specimens for tube may be taken from rings cut from the ends of the tube as shown in Fig. 14. Flattening of the specimen may be either after separating as in *A*, or before separating as in *B*. Transverse tension test specimens for large tube under 20 mm [0.750 in.] in wall thickness shall be either of the small-size specimens shown in Fig. 8 or of the form and dimensions shown for Specimen 2 in Fig. 13. When using the latter specimen, either or both surfaces of the specimen may be machined to secure a uniform thickness, provided not more than 15 % of the normal wall thickness is removed from each surface. For large tube 20 mm [0.750 in.] and over in wall thickness, the standard specimen shown in Fig. 8 shall be used for transverse tension tests. Specimens for transverse tension tests on large welded tube to determine the strength of welds shall be located perpendicular to the welded seams, with the welds at about the middle of their lengths.

 **E8/E8M – 15a**

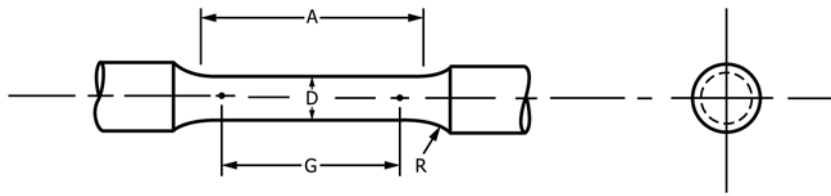

Dimensions, mm [in.]

**For Test Specimens with Gauge Length Four times the Diameter [E8]**

	Standard Specimen		Small-Size Specimens Proportional to Standard		
	Specimen 1	Specimen 2	Specimen 3	Specimen 4	Specimen 5
G—Gauge length	50.0 ± 0.1 [2.000 ± 0.005]	36.0 ± 0.1 [1.400 ± 0.005]	24.0 ± 0.1 [1.000 ± 0.005]	16.0 ± 0.1 [0.640 ± 0.005]	10.0 ± 0.1 [0.450 ± 0.005]
D—Diameter (Note 1)	12.5 ± 0.2 [0.500 ± 0.010]	9.0 ± 0.1 [0.350 ± 0.007]	6.0 ± 0.1 [0.250 ± 0.005]	4.0 ± 0.1 [0.160 ± 0.003]	2.5 ± 0.1 [0.113 ± 0.002]
R—Radius of fillet, min	10 [0.375]	8 [0.25]	6 [0.188]	4 [0.156]	2 [0.094]
A—Length of reduced section, min (Note 2)	56 [2.25]	45 [1.75]	30 [1.25]	20 [0.75]	16 [0.625]

Dimensions, mm [in.]

**For Test Specimens with Gauge Length Five times the Diameter [E8M]**

	Standard Specimen		Small-Size Specimens Proportional to Standard		
	Specimen 1	Specimen 2	Specimen 3	Specimen 4	Specimen 5
G—Gauge length	62.5 ± 0.1 [2.500 ± 0.005]	45.0 ± 0.1 [1.750 ± 0.005]	30.0 ± 0.1 [1.250 ± 0.005]	20.0 ± 0.1 [0.800 ± 0.005]	12.5 ± 0.1 [0.565 ± 0.005]
D—Diameter (Note 1)	12.5 ± 0.2 [0.500 ± 0.010]	9.0 ± 0.1 [0.350 ± 0.007]	6.0 ± 0.1 [0.250 ± 0.005]	4.0 ± 0.1 [0.160 ± 0.003]	2.5 ± 0.1 [0.113 ± 0.002]
R—Radius of fillet, min	10 [0.375]	8 [0.25]	6 [0.188]	4 [0.156]	2 [0.094]
A—Length of reduced section, min (Note 2)	75 [3.0]	54 [2.0]	36 [1.4]	24 [1.0]	20 [0.75]

NOTE 1—The reduced section may have a gradual taper from the ends toward the center, with the ends not more than 1 % larger in diameter than the center (controlling dimension).

NOTE 2—If desired, the length of the reduced section may be increased to accommodate an extensometer of any convenient gauge length. Reference marks for the measurement of elongation should, nevertheless, be spaced at the indicated gauge length.

NOTE 3—The gauge length and fillets may be as shown, but the ends may be of any form to fit the holders of the testing machine in such a way that the force shall be axial (see Fig. 9). If the ends are to be held in wedge grips it is desirable, if possible, to make the length of the grip section great enough to allow the specimen to extend into the grips a distance equal to two thirds or more of the length of the grips.

NOTE 4—On the round specimens in Figs. 8 and 9, the gauge lengths are equal to four [E8] or five times [E8M] the nominal diameter. In some product specifications other specimens may be provided for, but unless the 4-to-1 [E8] or 5-to-1 [E8M] ratio is maintained within dimensional tolerances, the elongation values may not be comparable with those obtained from the standard test specimen.

NOTE 5—The use of specimens smaller than 6-mm [0.250-in.] diameter shall be restricted to cases when the material to be tested is of insufficient size to obtain larger specimens or when all parties agree to their use for acceptance testing. Smaller specimens require suitable equipment and greater skill in both machining and testing.

NOTE 6—For inch/pound units only: Five sizes of specimens often used have diameters of approximately 0.505, 0.357, 0.252, 0.160, and 0.113 in., the reason being to permit easy calculations of stress from loads, since the corresponding cross-sectional areas are equal or close to 0.200, 0.100, 0.0500, 0.0200, and 0.0100 in.<sup>2</sup>, respectively. Thus, when the actual diameters agree with these values, the stresses (or strengths) may be computed using the simple multiplying factors 5, 10, 20, 50, and 100, respectively. (The metric equivalents of these five diameters do not result in correspondingly convenient cross-sectional areas and multiplying factors.)

**FIG. 8 Standard 12.5-mm [0.500-in.] Round Tension Test Specimen and Examples of Small-Size Specimens Proportional to the Standard Specimen**



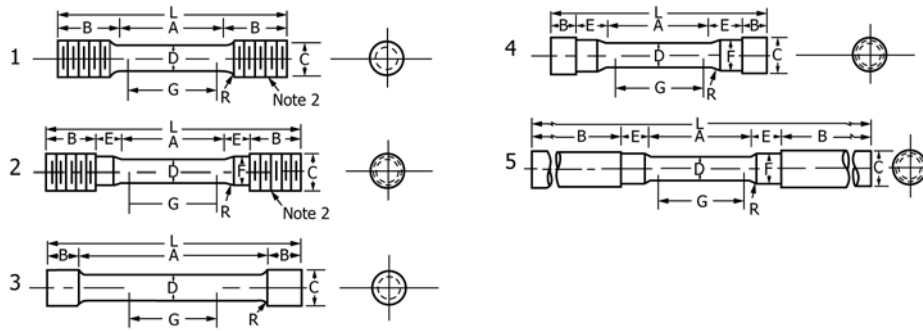

Dimensions, mm [in.]

**For Test Specimens with Gauge Length Four times the Diameter [E8]**

	Specimen 1	Specimen 2	Specimen 3	Specimen 4	Specimen 5
G—Gauge length	50 ± 0.1 [2.000 ± 0.005]	50 ± 0.1 [2.000 ± 0.005]	50 ± 0.1 [2.000 ± 0.005]	50 ± 0.1 [2.000 ± 0.005]	50 ± 0.1 [2.000 ± 0.005]
D—Diameter (Note 1)	12.5 ± 0.2 [0.500 ± 0.010]	12.5 ± 0.2 [0.500 ± 0.010]	12.5 ± 0.2 [0.500 ± 0.010]	12.5 ± 0.2 [0.500 ± 0.010]	12.5 ± 0.2 [0.500 ± 0.010]
R—Radius of fillet, min	10 [0.375]	10 [0.375]	2 [0.0625]	10 [0.375]	10 [0.375]
A—Length of reduced section	56 [2.25]	56 [2.25]	100 [4]	56 [2.25]	56 [2.25]
L—Overall length, approximate	145 [5]	155 [5.5]	155 [5.5]	140 [4.75]	255 [9.5]
B—Length of end section (Note 3)	35 [1.375] approximate	25 [1] approximate	20 [0.75] approximate	15 [0.5] approximate	75 [3] min
C—Diameter of end section	20 [0.75]	20 [0.75]	20 [0.75]	20 [0.75]	20 [0.75]
E—Length of shoulder and fillet section, approximate		15 [0.625]		20 [0.75]	15 [0.625]
F—Diameter of shoulder		15 [0.625]		15 [0.625]	15 [0.625]

Dimensions, mm [in.]

**For Test Specimens with Gauge Length Five times the Diameter [E8M]**

	Specimen 1	Specimen 2	Specimen 3	Specimen 4	Specimen 5
G—Gauge length	62.5 ± 0.1 [2.500 ± 0.005]	62.5 ± 0.1 [2.500 ± 0.005]	62.5 ± 0.1 [2.500 ± 0.005]	62.5 ± 0.1 [2.500 ± 0.005]	62.5 ± 0.1 [2.500 ± 0.005]
D—Diameter (Note 1)	12.5 ± 0.2 [0.500 ± 0.010]	12.5 ± 0.2 [0.500 ± 0.010]	12.5 ± 0.2 [0.500 ± 0.010]	12.5 ± 0.2 [0.500 ± 0.010]	12.5 ± 0.2 [0.500 ± 0.010]
R—Radius of fillet, min	10 [0.375]	10 [0.375]	2 [0.0625]	10 [0.375]	10 [0.375]
A—Length of reduced section	75 [3] min	75 [3] min	75 [3] approximate	75 [3] min	75 [3] min
L—Overall length, approximate	145 [5]	155 [5.5]	155 [5.5]	140 [4.75]	255 [9.5]
B—Length of end section (Note 3)	35 [1.375] approximate	25 [1] approximate	20 [0.75] approximate	15 [0.5] approximate	75 [3] min
C—Diameter of end section	20 [0.75]	20 [0.75]	20 [0.75]	22 [0.875]	20 [0.75]
E—Length of shoulder and fillet section, approximate		15 [0.625]		20 [0.75]	15 [0.625]
F—Diameter of shoulder		15 [0.625]		15 [0.625]	15 [0.625]

NOTE 1—The reduced section may have a gradual taper from the ends toward the center with the ends not more than 1 % larger in diameter than the center.

NOTE 2—On Specimens 1 and 2, any standard thread is permissible that provides for proper alignment and aids in assuring that the specimen will break within the reduced section.

NOTE 3—On Specimen 5 it is desirable, if possible, to make the length of the grip section great enough to allow the specimen to extend into the grips a distance equal to two thirds or more of the length of the grips.

NOTE 4—The values stated in SI units in the table for Fig. 9 are to be regarded as separate from the inch/pound units. The values stated in each system are not exact equivalents; therefore each system must be used independently of the other.

**FIG. 9 Various Types of Ends for Standard Round Tension Test Specimens**

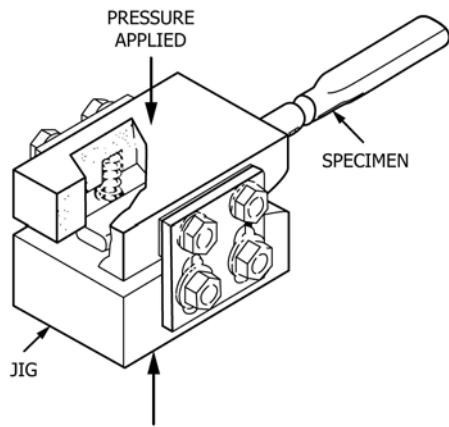
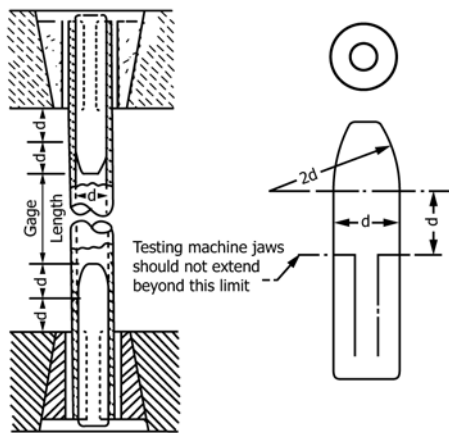
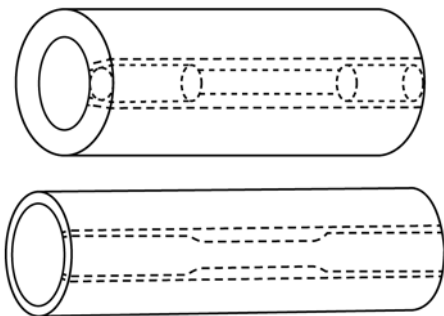

FIG. 10 Squeezing Jig for Flattening Ends of Full-Size Tension Test Specimens



NOTE 1—The diameter of the plug shall have a slight taper from the line limiting the test machine jaws to the curved section.

FIG. 11 Metal Plugs for Testing Tubular Specimens, Proper Location of Plugs in Specimen and of Specimen in Heads of Testing Machine



NOTE 1—The edges of the blank for the specimen shall be cut parallel to each other.

FIG. 12 Location from Which Longitudinal Tension Test Specimens Are to be Cut from Large-Diameter Tube

6.10 *Specimens for Forgings*—For testing forgings, the largest round specimen described in 6.4 shall be used. If round specimens are not feasible, then the largest specimen described in 6.5 shall be used.

6.10.1 For forgings, specimens shall be taken as provided in the applicable product specifications, either from the predomi-

nant or thickest part of the forging from which a coupon can be obtained, or from a prolongation of the forging, or from separately forged coupons representative of the forging. When not otherwise specified, the axis of the specimen shall be parallel to the direction of grain flow.

6.11 *Specimens for Castings*—In testing castings either the standard specimen shown in Fig. 8 or the specimen shown in Fig. 15 shall be used unless otherwise provided in the product specifications.

6.11.1 Test coupons for castings shall be made as shown in Fig. 16 and Table 1.

6.12 *Specimen for Malleable Iron*—For testing malleable iron the test specimen shown in Fig. 17 shall be used, unless otherwise provided in the product specifications.

6.13 *Specimen for Die Castings*—For testing die castings the test specimen shown in Fig. 18 shall be used unless otherwise provided in the product specifications.

6.14 *Specimens for Powder Metallurgy (P/M) Materials*—For testing powder metallurgy (P/M) materials the test specimens shown in Figs. 19 and 20 shall be used, unless otherwise provided in the product specifications. When making test specimens in accordance with Fig. 19, shallow transverse grooves, or ridges, may be pressed in the ends to allow gripping by jaws machined to fit the grooves or ridges. Because of shape and other factors, the flat unmachined tensile test specimen (Fig. 19) in the heat treated condition will have an ultimate tensile strength of 50 % to 85 % of that determined in a machined round tensile test specimen (Fig. 20) of like composition and processing.

## 7. Procedures

7.1 *Preparation of the Test Machine*—Upon startup, or following a prolonged period of machine inactivity, the test machine should be exercised or warmed up to normal operating temperatures to minimize errors that may result from transient conditions.

### 7.2 Measurement of Dimensions of Test Specimens:

7.2.1 To determine the cross-sectional area of a test specimen, measure the dimensions of the cross section at the center of the reduced section. For referee testing of specimens less than 5 mm [0.188 in.] in their least dimension, measure the dimensions where the least cross-sectional area is found. Measure and record the cross-sectional dimensions of tension test specimens as follows:

(1) Specimen dimension  $\geq 5$  mm [0.200 in.] to the nearest 0.02 mm [0.001 in.].

(2)  $2.5$  mm [0.100 in.]  $\leq$  Specimen dimension  $< 5$  mm [0.200 in.] to the nearest 0.01 mm [0.0005 in.].

(3)  $0.5$  mm [0.020 in.]  $\leq$  specimen dimension  $< 2.5$  mm [0.100 in.] to the nearest 0.002 mm [0.0001 in.].

(4) Specimen dimensions  $< 0.5$  mm [0.020 in.], to at least the nearest 1 % when practical but in all cases to at least the nearest 0.002 mm [0.0001 in.].

NOTE 9—Accurate and precise measurement of specimen dimensions can be one of the most critical aspects of tension testing, depending on specimen geometry. See Appendix X2 for additional information.

NOTE 10—Rough surfaces due to the manufacturing process such as hot

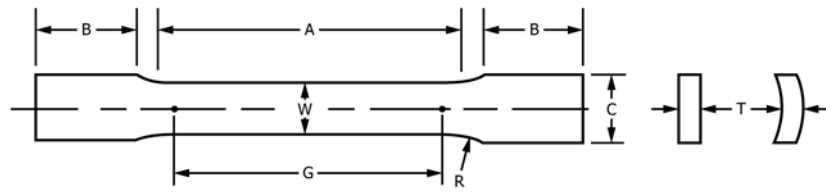

	Dimensions						
	Specimen 1	Specimen 2	Specimen 3	Specimen 4	Specimen 5	Specimen 6	Specimen 7
	mm [in.]	mm [in.]	mm [in.]	mm [in.]	mm [in.]	mm [in.]	mm [in.]
G—Gauge length	50.0 ± 0.1 [2.000 ± 0.005]	50.0 ± 0.1 [2.000 ± 0.005]	200.0 ± 0.2 [8.00 ± 0.01]	50.0 ± 0.1 [2.000 ± 0.005]	100.0 ± 0.1 [4.000 ± 0.005]	50.0 ± 0.1 [2.000 ± 0.005]	100.0 ± 0.1 [4.000 ± 0.005]
W—Width (Note 1)	12.5 ± 0.2 [0.500 ± 0.010]	40.0 ± 2.0 [1.5 ± 0.125-0.25]	40.0 ± 0.2 [1.5 ± 0.125,-0.25]	20.0 ± 0.7 [0.750 ± 0.031]	20.0 ± 0.7 [0.750 ± 0.031]	25.0 ± 1.5 [1.000 ± 0.062]	25.0 ± 1.5 [1.000 ± 0.062]
T—Thickness	measured thickness of specimen						
R—Radius of fillet, min	12.5 [0.5]	25 [1]	25 [1]	25 [1]	25 [1]	25 [1]	25 [1]
A—Length of reduced section, min	60 [2.25]	60 [2.25]	230 [9]	60 [2.25]	120 [4.5]	60 [2.25]	120 [4.5]
B—Length of grip section, min (Note 2)	75 [3]	75 [3]	75 [3]	75 [3]	75 [3]	75 [3]	75 [3]
C—Width of grip section, approximate (Note 3)	20 [0.75]	50 [2]	50 [2]	25 [1]	25 [1]	40 [1.5]	40 [1.5]

NOTE 1—The ends of the reduced section shall differ from each other in width by not more than 0.5 %. There may be a gradual taper in width from the ends to the center, but the width at each end shall be not more than 1 % greater than the width at the center.

NOTE 2—It is desirable, if possible, to make the length of the grip section great enough to allow the specimen to extend into the grips a distance equal to two thirds or more of the length of the grips.

NOTE 3—The ends of the specimen shall be symmetrical with the center line of the reduced section within 1 mm [0.05 in.] for specimens 1, 4, and 5, and 2.5 mm [0.10 in.] for specimens 2, 3, 6, and 7.

NOTE 4—For each specimen type, the radii of all fillets shall be equal to each other within a tolerance of 1.25 mm [0.05 in.], and the centers of curvature of the two fillets at a particular end shall be located across from each other (on a line perpendicular to the centerline) within a tolerance of 2.5 mm [0.10 in.].

NOTE 5—For circular segments, the cross-sectional area may be calculated by multiplying *W* and *T*. If the ratio of the dimension *W* to the diameter of the tubular section is larger than about 1/6 the error in using this method to calculate the cross-sectional area may be appreciable. In this case, the exact equation (see 7.2.3) must be used to determine the area.

NOTE 6—Specimens with *G/W* less than 4 should not be used for determination of elongation.

NOTE 7—Specimens with sides parallel throughout their length are permitted, except for referee testing, provided: (a) the above tolerances are used; (b) an adequate number of marks are provided for determination of elongation; and (c) when yield strength is determined, a suitable extensometer is used. If the fracture occurs at a distance of less than 2 *W* from the edge of the gripping device, the tensile properties determined may not be representative of the material. If the properties meet the minimum requirements specified, no further testing is required, but if they are less than the minimum requirements, discard the test and retest.

FIG. 13 Tension Test Specimens for Large-Diameter Tubular Products

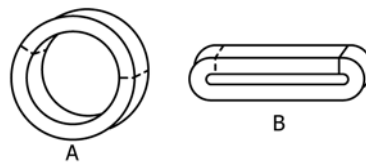

FIG. 14 Location of Transverse Tension Test Specimen in Ring Cut from Tubular Products

rolling, metallic coating, etc., may lead to inaccuracy of the computed areas greater than the measured dimensions would indicate. Therefore, cross-sectional dimensions of test specimens with rough surfaces due to processing may be measured and recorded to the nearest 0.02 mm [0.001 in.]

NOTE 11—See X2.9 for cautionary information on measurements taken from coated metal products.

7.2.2 Determine the cross-sectional area of a full-size test specimen of uniform but nonsymmetrical cross section by

determining the mass of a length not less than 20 times longer than the largest cross-sectional dimension.

7.2.2.1 Determine the weight to the nearest 0.5 % or less.

7.2.2.2 The cross-sectional area is equal to the mass of the specimen divided by the length and divided by the density of the material.

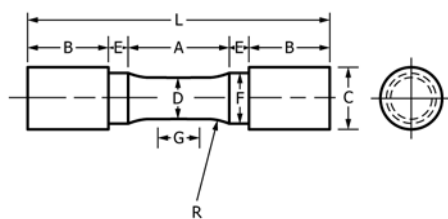

	Dimensions		
	Specimen 1	Specimen 2	Specimen 3
	mm [in.]	mm [in.]	mm [in.]
G—Length of parallel section	Shall be equal to or greater than diameter <i>D</i>		
D—Diameter	12.5 ± 0.2 [0.500 ± 0.010]	20 ± 0.4 [0.750 ± 0.015]	36.0 ± 0.6 [1.25 ± 0.02]
R—Radius of fillet, min	25 [1]	25 [1]	50 [2]
A—Length of reduced section, min	32 [1.25]	38 [1.5]	60 [2.25]
L—Overall length, min	95 [3.75]	100 [4]	160 [6.375]
B—Length of end section, approximate	25 [1]	25 [1]	45 [1.75]
C—Diameter of end section, approximate	20 [0.75]	30 [1.125]	48 [1.875]
E—Length of shoulder, min	6 [0.25]	6 [0.25]	8 [0.312]
F—Diameter of shoulder	16.0 ± 0.4 [0.625 ± 0.016]	24.0 ± 0.4 [0.94 ± 0.016]	36.5 ± 0.4 [1.438 ± 0.016]

NOTE 1—The reduced section and shoulders (dimensions *A*, *D*, *E*, *F*, *G*, and *R*) shall be as shown, but the ends may be of any form to fit the holders of the testing machine in such a way that the force can be axial. Commonly the ends are threaded and have the dimensions *B* and *C* given above.

FIG. 15 Standard Tension Test Specimen for Cast Iron

7.2.3 When using specimens of the type shown in Fig. 13 taken from tubes, the cross-sectional area shall be determined as follows:

If  $D/W \leq 6$ :

$$A = \left[ \left( \frac{W}{4} \right) \times \sqrt{D^2 - W^2} \right] + \left[ \left( \frac{D^2}{4} \right) \times \arcsin \left( \frac{W}{D} \right) \right] - \left[ \left( \frac{W}{4} \right) \times \sqrt{(D - 2T)^2 - W^2} \right] - \left[ \left( \frac{D - 2T}{2} \right)^2 \times \arcsin \left( \frac{W}{D - 2T} \right) \right] \quad (1)$$

where:

- A* = exact cross-sectional area, mm<sup>2</sup> [in.<sup>2</sup>],
- W* = width of the specimen in the reduced section, mm [in.],
- D* = measured outside diameter of the tube, mm [in.], and
- T* = measured wall thickness of the specimen, mm [in.].

arcsin values to be in radians

If  $D/W > 6$ , the exact equation or the following equation may be used:

$$A = W \times T \quad (2)$$

where:

- A* = approximate cross-sectional area, mm<sup>2</sup> [in.<sup>2</sup>],
- W* = width of the specimen in the reduced section, mm [in.], and
- T* = measured wall thickness of the specimen, mm [in.].

NOTE 12—See X2.8 for cautionary information on measurements and

calculations for specimens taken from large-diameter tubing.

### 7.3 Gauge Length Marking of Test Specimens:

7.3.1 The gauge length for the determination of elongation shall be in accordance with the product specifications for the material being tested. Gauge marks shall be stamped lightly with a punch, scribed lightly with dividers or drawn with ink as preferred. For material that is sensitive to the effect of slight notches and for small specimens, the use of layout ink will aid in locating the original gauge marks after fracture.

7.3.2 For materials where the specified elongation is 3 % or less, measure the original gauge length to the nearest 0.05 mm [0.002 in.] prior to testing.

### 7.4 Zeroing of the Testing Machine:

7.4.1 The testing machine shall be set up in such a manner that zero force indication signifies a state of zero force on the specimen. Any force (or preload) imparted by the gripping of the specimen (see Note 13) must be indicated by the force measuring system unless the preload is physically removed prior to testing. Artificial methods of removing the preload on the specimen, such as taring it out by a zero adjust pot or removing it mathematically by software, are prohibited because these would affect the accuracy of the test results.

NOTE 13—Preloads generated by gripping of specimens may be either tensile or compressive in nature and may be the result of such things as:

- grip design
- malfunction of gripping apparatus (sticking, binding, etc.)
- excessive gripping force
- sensitivity of the control loop

NOTE 14—It is the operator's responsibility to verify that an observed preload is acceptable and to ensure that grips operate in a smooth manner. Unless otherwise specified, it is recommended that momentary (dynamic) forces due to gripping not exceed 20 % of the material's nominal yield strength and that static preloads not exceed 10 % of the material's nominal yield strength.

### 7.5 Gripping of the Test Specimen:

7.5.1 For specimens with reduced sections, gripping of the specimen shall be restricted to the grip section, because gripping in the reduced section or in the fillet can significantly affect test results.

### 7.6 Speed of Testing:

7.6.1 Speed of testing may be defined in terms of (a) rate of straining of the specimen, (b) rate of stressing of the specimen, (c) crosshead speed, (d) the elapsed time for completing part or all of the test, or (e) free-running crosshead speed (rate of movement of the crosshead of the testing machine when not under load).

7.6.2 Specifying suitable numerical limits for speed and selection of the method are the responsibilities of the product committees. Suitable limits for speed of testing should be specified for materials for which the differences resulting from the use of different speeds are of such magnitude that the test results are unsatisfactory for determining the acceptability of the material. In such instances, depending upon the material and the use for which the test results are intended, one or more of the methods described in the following paragraphs is recommended for specifying speed of testing.

NOTE 15—Speed of testing can affect test values because of the rate sensitivity of materials and the temperature-time effects.

**TABLE 1 Details of Test Coupon Design for Castings (see Fig. 16)**

NOTE 1—*Test Coupons for Large and Heavy Steel Castings*: The test coupons in Fig. 16A and B are to be used for large and heavy steel castings. However, at the option of the foundry the cross-sectional area and length of the standard coupon may be increased as desired. This provision does not apply to Specification A356/A356M.

NOTE 2—*Bend Bar*: If a bend bar is required, an alternate design (as shown by dotted lines in Fig. 16) is indicated.

Leg Design, 125 mm [5 in.]		Riser Design	
1. <i>L</i> (length)	A 125mm [5-in.] minimum length will be used. This length may be increased at the option of the foundry to accommodate additional test bars (see Note 1).	1. <i>L</i> (length)	The length of the riser at the base will be the same as the top length of the leg. The length of the riser at the top therefore depends on the amount of taper added to the riser. The width of the riser at the base of a multiple-leg coupon shall be $n$ (57 mm) – 16 mm [ $n$ (2.25 in.) – 0.625 in.] where $n$ equals the number of legs attached to the coupon. The width of the riser at the top is therefore dependent on the amount of taper added to the riser.
2. End taper	Use of and size of end taper is at the option of the foundry.	2. Width	
3. Height	32 mm [1.25 in.]		
4. Width (at top)	32 mm [1.25 in.] (see Note 1)		
5. Radius (at bottom)	13 mm [0.5 in.] max		
6. Spacing between legs	A 13 mm [0.5 in.] radius will be used between the legs.		
7. Location of test bars	The tensile, bend, and impact bars will be taken from the lower portion of the leg (see Note 2).		
8. Number of legs	The number of legs attached to the coupon is at the option of the foundry providing they are equispaced according to Item 6.	3. <i>T</i> (riser taper) Height	Use of and size is at the option of the foundry. The minimum height of the riser shall be 51 mm [2 in.]. The maximum height is at the option of the foundry for the following reasons: (a) many risers are cast open, (b) different compositions may require variation in risering for soundness, or (c) different pouring temperatures may require variation in risering for soundness.
9. $R_x$	Radius from 0 to approximately 2 mm [0.062 in.]		

7.6.2.1 *Rate of Straining*—The allowable limits for rate of straining shall be specified in mm/mm/min [in./in./min]. Some testing machines are equipped with pacing or indicating devices for the measurement and control of rate of straining, but in the absence of such a device the average rate of straining can be determined with a timing device by observing the time required to effect a known increment of strain.

7.6.2.2 *Rate of Stressing*—The allowable limits for rate of stressing shall be specified in megapascals per second [pounds per square inch per minute]. Many testing machines are equipped with pacing or indicating devices for the measurement and control of the rate of stressing, but in the absence of such a device the average rate of stressing can be determined with a timing device by observing the time required to apply a known increment of stress.

7.6.2.3 *Crosshead Speed*—The allowable limits for crosshead speed, during a test, may be specified in mm/min [in./min]; in this case, the limits for the crosshead speed should be further qualified by specifying different limits for various types and sizes of specimens. In cases where different length specimens may be used, it is often more practical to specify the crosshead speed in terms of mm [in.] per mm [in.] of length of the original reduced section of the specimen (or distance between grips for specimens not having reduced sections) per minute. Many testing machines are equipped with pacing or indicating devices for the measurement and control of the crosshead speed during a test, but in the absence of such devices the average crosshead speed can be experimentally determined by using suitable length-measuring and timing devices.

NOTE 16—This method of specifying speed of testing, “Crosshead Speed”, was previously called “Rate of Separation of Heads During Tests.”

NOTE 17—For machines not having crossheads or having stationary crossheads, the phrase “crosshead speed” may be interpreted to mean the rate of grip separation.

7.6.2.4 *Elapsed Time*—The allowable limits for the elapsed time from the beginning of force application (or from some specified stress) to the instant of fracture, to the maximum force, or to some other stated stress, shall be specified in minutes or seconds. The elapsed time can be determined with a timing device.

7.6.2.5 *Free-Running Crosshead Speed*—The allowable limits for the rate of movement of the crosshead of the testing machine, with no force applied by the testing machine, shall be specified in mm per mm [inches per inch] of length of reduced section (or distance between grips for specimens not having reduced sections) per second [minute]. The limits for the crosshead speed may be further qualified by specifying different limits for various types and sizes of specimens. The average crosshead speed can be experimentally determined by using suitable length-measuring and timing devices.

NOTE 18—For machines not having crossheads or having stationary crossheads, the phrase “free-running crosshead speed” may be interpreted to mean the free-running rate of grip separation.

7.6.3 *Speed of Testing When Determining Yield Properties*—Unless otherwise specified, any convenient speed of testing may be used up to one half the specified minimum yield strength or up to one quarter of the specified minimum tensile strength, whichever is smaller. The speed above this point shall

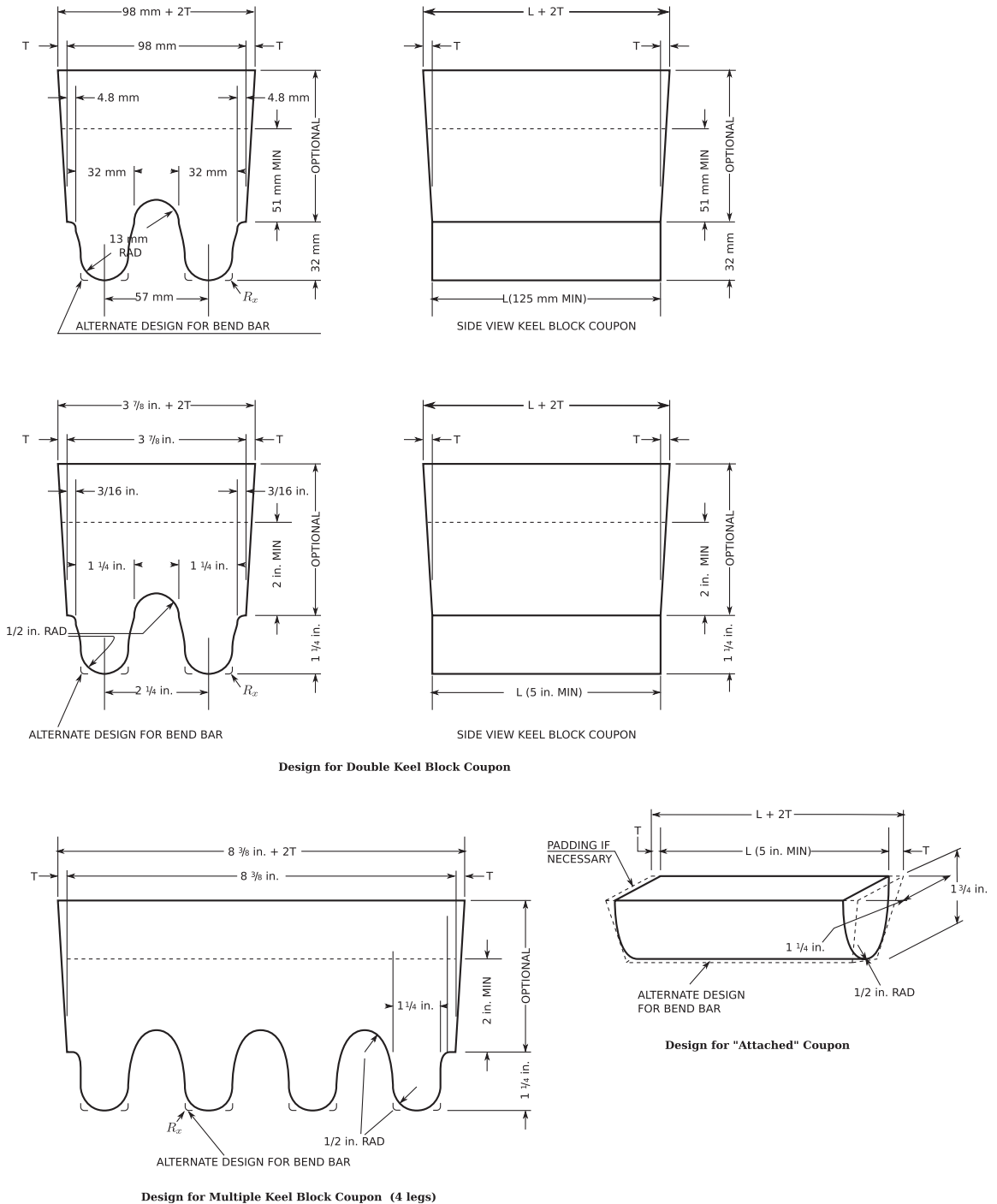
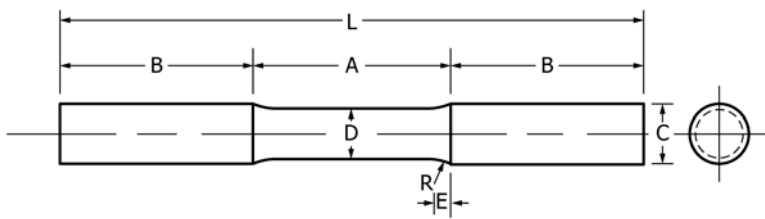

FIG. 16 Test Coupons for Castings



Dimensions, mm [in.]

D—Diameter	16 [0.625]
R—Radius of fillet	8 [0.312]
A—Length of reduced section	64 [2.5]
L—Overall length	190 [7.5]
B—Length of end section	64 [2.5]
C—Diameter of end section	20 [0.75]
E—Length of fillet	5 [0.188]

FIG. 17 Standard Tension Test Specimen for Malleable Iron

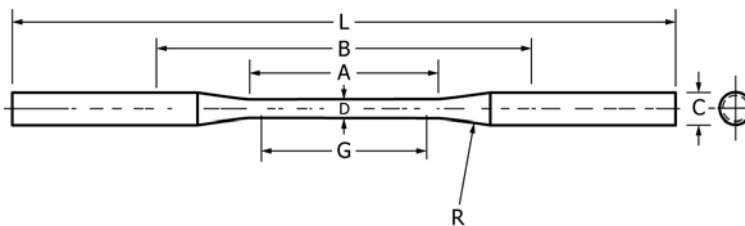

Dimensions, mm [in.]

G—Gauge length	50 ± 0.1 [2.000 ± 0.005]
D—Diameter (see Note)	6.4 ± 0.1 [0.250 ± 0.005]
R—Radius of fillet, min	75 [3]
A—Length of reduced section, min	60 [2.25]
L—Overall length, min	230 [9]
B—Distance between grips, min	115 [4.5]
C—Diameter of end section, approximate	10 [0.375]

NOTE 1—The reduced section may have a gradual taper from the end toward the center, with the ends not more than 0.1 mm [0.005 in.] larger in diameter than the center.

FIG. 18 Standard Tension Test Specimens for Die Castings

be within the specified limits. If different speed limitations are required for use in determining yield strength, yield point elongation, tensile strength, elongation, and reduction of area, they should be stated in the product specifications. In all cases, the speed of testing shall be such that the forces and strains used in obtaining the test results are accurately indicated. Determination of mechanical properties for comparison of product properties against a specification value should be run using the same control method and rate used to determine the specification value unless it can be shown that another method yields equivalent or conservative results. In the absence of any specified limitations, one of the following control methods shall be used. Appendix X4 provides additional guidance on selecting the control method.

NOTE 19—In the previous and following paragraphs, the yield properties referred to include yield strength, yield point, and yield point elongation.

7.6.3.1 Control Method A—Rate of Stressing Method for Determining Yield Properties - In this method, the testing machine shall be operated such that the rate of stress application in the linear elastic region is between 1.15 and 11.5 MPa/s

[10 000 and 100 000 psi/min]. The speed of the testing machine shall not be increased in order to maintain a stressing rate when the specimen begins to yield. It is not recommended that the testing machine be operated in closed-loop control using the force signal through yield; however closed-loop control of the force signal can be used in the linear-elastic portion of the test.

NOTE 20—It is not the intent of this method to maintain constant stress rate or to control stress rate with closed loop force control while determining yield properties, but only to set the crosshead speed to achieve the target stress rate in the elastic region. When a specimen being tested begins to yield, the stressing rate decreases and may even become negative in the case of a specimen with discontinuous yielding. To maintain a constant stressing rate through the yielding process requires the testing machine to operate at extremely high speeds and, in most cases, this is neither practical nor desirable. In practice, it is simpler to use either a strain rate, crosshead speed, or a free-running crosshead speed that approximates the desired stressing rate in the linear-elastic portion of the test. As an example, use a strain rate that is between 1.15 and 11.5 MPa/s divided by the nominal Young's Modulus of the material being tested. As another example, find a crosshead speed through experimentation that approximates the desired stressing rate prior to the onset of yielding, and maintain that crosshead speed through the region that yield properties are determined. While both of these methods will provide similar rates of stressing and straining prior to the onset of yielding, the rates of stressing

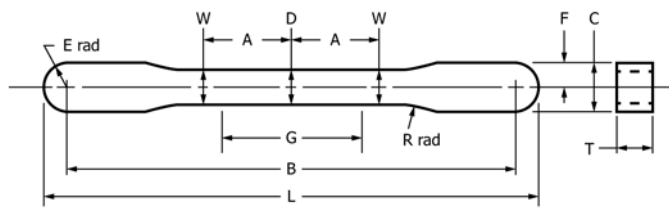

Pressing Area = 645 mm<sup>2</sup> [1.00 in.<sup>2</sup>]

Dimensions, mm [in.]

G—Gauge length	25.4 ± 0.08 [1.000 ± 0.003]
D—Width at center	5.72 ± 0.03 [0.225 ± 0.001]
W—Width at end of reduced section	5.97 ± 0.03 [0.235 ± 0.001]
T—Compact to this thickness	3.56 to 6.35 [0.140 to 0.250]
R—Radius of fillet	25.4 [1]
A—Half-length of reduced section	15.9 [0.625]
B—Grip length	80.95 ± 0.03 [3.187 ± 0.001]
L—Overall length	89.64 ± 0.03 [3.529 ± 0.001]
C—Width of grip section	8.71 ± 0.03 [0.343 ± 0.001]
F—Half-width of grip section	4.34 ± 0.03 [0.171 ± 0.001]
E—End radius	4.34 ± 0.03 [0.171 ± 0.001]

NOTE 1—Dimensions Specified, except G and T, are those of the die.

FIG. 19 Standard Flat Unmachined Tension Test Specimens for Powder Metallurgy (P/M) Products

and straining are generally quite different in the region where yield properties are determined.

NOTE 21—This method has been the default method for many years for testing materials that exhibit low strain rate sensitivity such as some steels and aluminum.

**7.6.3.2 Control Method B - Rate of Straining Control Method for Determining Yield Properties**—In this method, the testing machine shall be operated in closed-loop control using the extensometer signal. The rate of straining shall be set and maintained at 0.015 ± 0.006 mm/mm/min [in./in./min].

NOTE 22—Proper precautions must be observed when operating a machine in closed-loop strain control because unexpected crosshead movement may occur if the control parameters are not set properly, if proper safety limits are not set, or if the extensometer slips.

NOTE 23—A Rate of Straining at 0.005 mm/mm/min [in./in./min] is often required for aerospace, high-temperature alloys, and titanium applications and when specified, must be followed rather than the requirement above.

**7.6.3.3 Control Method C—Crosshead Speed Control Method for Determining Yield Properties**—The testing machine shall be set to a crosshead speed equal to 0.015 ± 0.003 mm/mm/min [in./in./min] of the original reduced section (dimension A in Fig. 1, Fig. 7, Fig. 8, Fig. 9, Fig. 13, Fig. 15, Fig. 17, Fig. 18, and Fig. 20, and 2 times dimension A in Fig. 19) or distance between grips for specimens without reduced sections.

NOTE 24—It is recommended that crosshead speed be used for control in regions of discontinuous yielding.

NOTE 25—Using different Control Methods may produce different yield results especially if the material being tested is strain-rate sensitive. To achieve the best reproducibility in cases where the material may be strain-rate sensitive, the same control method should be used. Methods described in 7.6.3.2 or 7.6.3.3 will tend to give similar results in the case of a strain-rate sensitive material. The control method described in 7.6.3.1 should be avoided for strain rate sensitive materials if it is desirable to

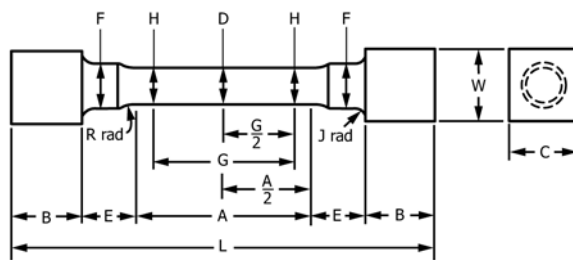

Approximate Pressing Area of Unmachined Compact = 752 mm<sup>2</sup> [1.166 in.<sup>2</sup>]

- Machining Recommendations
1. Rough machine reduced section to 6.35-mm [0.25-in.] diameter
  2. Finish turn 4.75/4.85-mm [0.187/0.191-in.] diameter with radii and taper
  3. Polish with 00 emery cloth
  4. Lap with crocus cloth

Dimensions, mm [in.]

G—Gauge length	25.4 ± 0.08 [1.000 ± 0.003]
D—Diameter at center of reduced section	4.75 ± 0.03 [0.187 ± 0.001]
H—Diameter at ends of gauge length	4.85 ± 0.03 [0.191 ± 0.001]
R—Radius of gauge fillet	6.35 ± 0.13 [0.250 ± 0.005]
A—Length of reduced section	47.63 ± 0.13 [1.875 ± 0.003]
L—Overall length (die cavity length)	75 [3], nominal
B—Length of end section	7.88 ± 0.13 [0.310 ± 0.005]
C—Compact to this end thickness	10.03 ± 0.13 [0.395 ± 0.005]
W—Die cavity width	10.03 ± 0.08 [0.395 ± 0.003]
E—Length of shoulder	6.35 ± 0.13 [0.250 ± 0.005]
F—Diameter of shoulder	7.88 ± 0.03 [0.310 ± 0.001]
J—End fillet radius	1.27 ± 0.13 [0.050 ± 0.005]

NOTE 1—The gauge length and fillets of the specimen shall be as shown. The ends as shown are designed to provide a practical minimum pressing area. Other end designs are acceptable, and in some cases are required for high-strength sintered materials.

NOTE 2—It is recommended that the test specimen be gripped with a split collet and supported under the shoulders. The radius of the collet support circular edge is to be not less than the end fillet radius of the test specimen.

NOTE 3—Diameters D and H are to be concentric within 0.03 mm [0.001 in.] total indicator runout (T.I.R.), and free of scratches and tool marks.

FIG. 20 Standard Round Machined Tension Test Specimen for Powder Metallurgy (P/M) Products

reproduce similar test results on other testing machines or in other laboratories.

**7.6.4 Speed of Testing When Determining Tensile Strength**—In the absence of any specified limitations on speed of testing, the following general rules shall apply for materials with expected elongations greater than 5 %. When determining only the tensile strength, or after the yield behavior has been recorded, the speed of the testing machine shall be set between 0.05 and 0.5 mm/mm [or in./in.] of the length of the reduced section (or distance between the grips for specimens not having a reduced section) per minute. Alternatively, an extensometer and strain rate indicator may be used to set the strain rate between 0.05 and 0.5 mm/mm/min [or in./in./min].

NOTE 26—For materials with expected elongations less than or equal to 5 %, the speed of the testing machine may be maintained throughout the test at the speed used to determine yield properties.

NOTE 27—Tensile strength and elongation are sensitive to test speed for many materials (see Appendix X1) to the extent that variations within the range of test speeds given above can significantly affect results.



7.7 Determination of Yield Strength—Determine yield strength by any of the methods described in 7.7.1 to 7.7.4. Where extensometers are employed, use only those that are verified over a strain range in which the yield strength will be determined (see 5.4).

NOTE 28—For example, a verified strain range of 0.2 % to 2.0 % is appropriate for use in determining the yield strengths of many metals.

NOTE 29—Determination of yield behavior on materials that cannot support an appropriate extensometer (thin wire, for example) is problematic and outside the scope of this standard.

NOTE 30—Yield properties of materials exhibiting yield point elongation (YPE) are often less repeatable and less reproducible than those of similar materials having no YPE. Offset and extension-under-load (EUL) yield strengths may be significantly affected by stress fluctuations occurring in the region where the offset or extension intersects the stress-strain curve. Determination of upper or lower yield strengths (or both) may therefore be preferable for such materials, although these properties depend on variables such as test machine stiffness and alignment and speed of testing.

7.7.1 Offset Method—On the stress-strain diagram (Fig. 21) lay off  $Om$  equal to the specified value of the offset, draw  $mn$  parallel to  $OA$ , and thus locate  $r$ , the intersection of  $mn$  with the stress-strain curve. In reporting values of yield strength obtained by this method, the specified value of offset used should be stated in parentheses after the term yield strength. Thus:

$$\text{Yield strength (offset = 0.2 \%)} = 360 \text{ MPa [52 000 psi]} \quad (3)$$

In using this method, a Class B2 or better extensometer (see Practice E83) shall be used.

NOTE 31—There are two general types of extensometers, averaging and non-averaging, the use of which depends on the product tested. For most machined specimens, the differences are small. However, for some forgings and tube sections, significant differences in measured yield strength can occur. For these cases, the averaging type should be used.

NOTE 32—When there is a disagreement over yield properties, the offset method for determining yield strength is recommended as the referee test method.

NOTE 33—In practice, for a number of reasons, the straight-line portion of the stress-strain curve (line  $OA$  shown in Fig. 21) may not go through the origin of the stress-strain diagram. Appendix X5 shows examples of non-ideal behavior and suggests methods for computing the yield strength from these non-ideal stress-strain diagrams.

7.7.2 Extension-Under-Load (EUL) Method—Yield strength by the extension-under-load method may be determined in two

ways: (1) analyzing the stress-strain diagram to determine the stress value at the specified value of extension, or (2) using devices that indicate when the specified extension occurs, so that the stress then occurring may be determined, see also 7.7.2.1. Fig. 21 also illustrates the extension-under load method. Report the stress at the specified extension as follows:

$$\text{Yield strength (EUL = 0.5 \%)} = 370 \text{ MPa [53 500 psi]} \quad (4)$$

Extensometers and other devices used in determination of the extension shall meet or exceed Class B2 requirements (see Practice E83) at the strain of interest, except where use of low-magnification Class C devices is helpful, such as in facilitating measurement of YPE, if observed. If Class C devices are used, report their use with the results.

NOTE 34—The appropriate value of the total extension should be specified. For steels with nominal yield strengths of less than 550 MPa [80 000 psi], an appropriate value is 0.005 mm/mm [or in./in.] (0.5 %) of the gauge length. For higher strength steels, a greater extension or the offset method should be used.

7.7.2.1 When no other means of measuring elongation are available, a pair of dividers or similar device may be used to determine a point of detectable elongation between two gauge marks on the specimen. The gauge length shall be 50 mm [2 in.]. The stress corresponding to the load at the instant of detectable elongation may be recorded as the approximate extension-under-load yield strength.

7.7.3 Method for materials that exhibit discontinuous yielding—Construct a stress-strain (or force-elongation) diagram. Determine the upper or lower yield strength as follows:

7.7.3.1 Record the stress corresponding to the maximum force at the onset of discontinuous yielding as the upper yield strength as illustrated in Figs. 22 and 23. If multiple peaks are observed at the onset of discontinuous yielding, the first is considered the upper yield strength. (See Fig. 23.)

7.7.3.2 Record the minimum stress observed during discontinuous yielding (ignoring transient effects) as the lower yield strength. This is illustrated in Fig. 23.

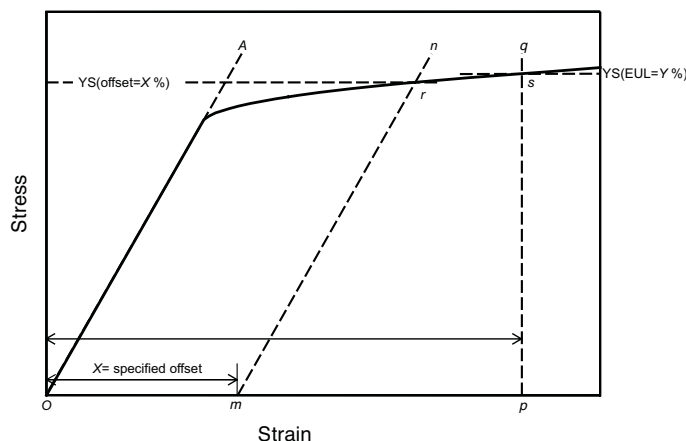

FIG. 21 Stress-Strain Diagram for Determination of Yield Strength by the Offset and Total Elongation

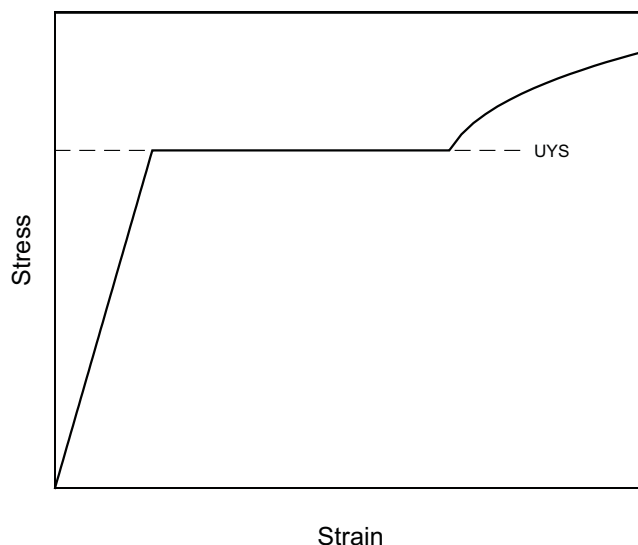

FIG. 22 Stress-Strain Diagram Showing Upper Yield Strength Corresponding with Top of Knee

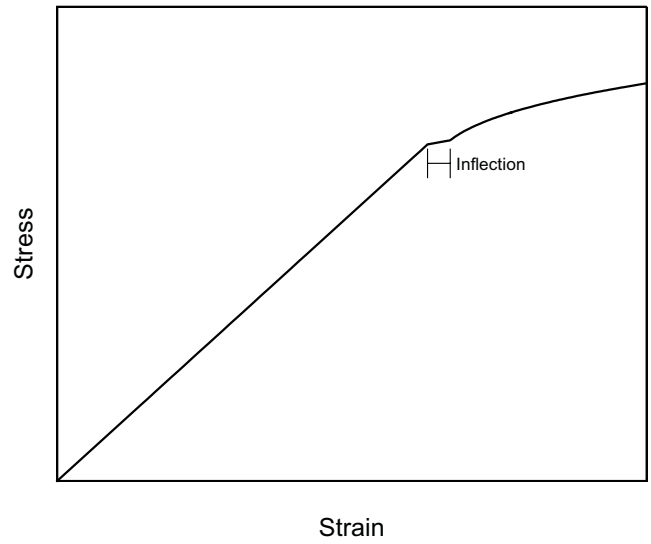
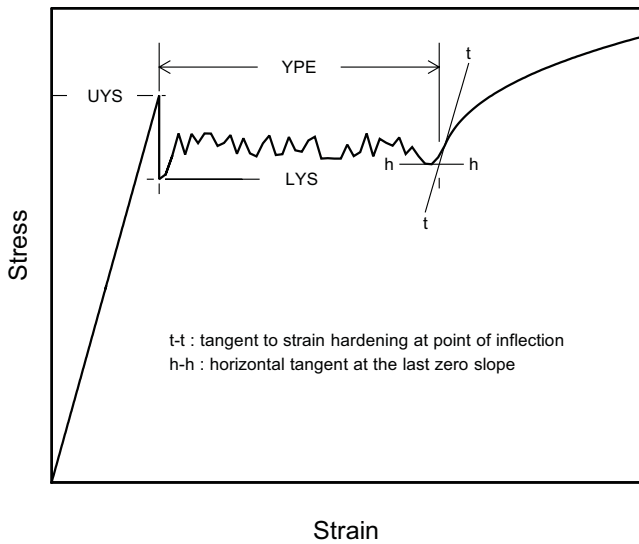

FIG. 23 Stress-Strain Diagram Showing Yield Point Elongation (YPE) and Upper (UYS) and Lower (LYS) Yield Strengths

FIG. 24 Stress-Strain Diagram With an Inflection, But No YPE

7.7.3.3 Where large-strain data are needed to facilitate measurement of yield point elongation for materials that may exhibit discontinuous yielding, Class C extensometers may be employed. When this is done but the material exhibits no discontinuous yielding, the extension-under-load yield strength may be determined instead, using the stress-strain curve (see Extension-Under-Load Method).

7.7.4 *Halt-of-the-Force Method for materials that exhibit discontinuous yielding*—Apply an increasing force to the specimen at a uniform deformation rate. When the force hesitates, record the corresponding stress as the upper yield strength.

NOTE 35—The Halt-of-the-Force Method was formerly known as the Halt-of-the-Pointer Method, the Drop-of-the-Beam Method, and the Halt-of-the-Load Method.

7.8 *Yield Point Elongation*—Calculate the yield point elongation from the stress-strain diagram or data by determining the difference in strain between the upper yield strength (first zero slope) and the onset of uniform strain hardening (see definition of YPE in Terminology E6 and Fig. 23).

NOTE 36—The stress-strain curve of a material exhibiting only a hint of the behavior causing YPE may have an inflection at the onset of yielding with no point where the slope reaches zero (Fig. 24). Such a material has no YPE, but may be characterized as exhibiting an inflection. Materials exhibiting inflections, like those with measurable YPE, may in certain applications acquire an unacceptable surface appearance during forming.

7.9 *Uniform Elongation (if required):*

7.9.1 Uniform elongation shall include both plastic and elastic elongation.

7.9.2 Uniform elongation shall be determined using autographic methods with extensometers conforming to Practice E83. Use a class B2 or better extensometer for materials having a uniform elongation less than 5 %. Use a class C or better extensometer for materials having a uniform elongation greater than or equal to 5 % but less than 50 %. Use a class D or better extensometer for materials having a uniform elongation of 50 % or greater.

7.9.3 Determine the uniform elongation as the elongation at the point of maximum force from the force elongation data collected during a test.

7.9.3.1 Some materials exhibit a yield point followed by considerable elongation where the yield point is the maximum force achieved during the test. In this case, uniform elongation is not determined at the yield point, but instead at the highest force occurring just prior to necking (see Fig. 25).

7.9.3.2 Stress-strain curves for some materials exhibit a lengthy, plateau-like region in the vicinity of the maximum force. For such materials, determine the uniform elongation at the center of the plateau as indicated in Fig. 26 (see also Note 37 below).

NOTE 37—When uniform elongation is being determined digitally, noise in the stress-strain data generally causes many small, local peaks and valleys to be recorded in the plateau region. To accommodate this, the following procedure is recommended:

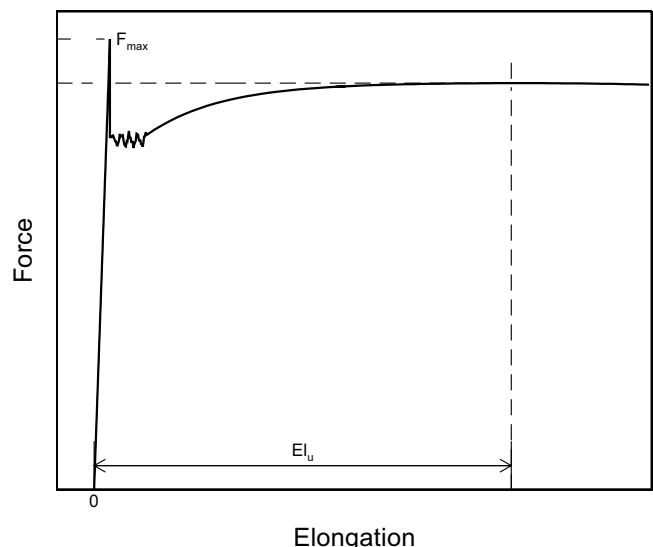
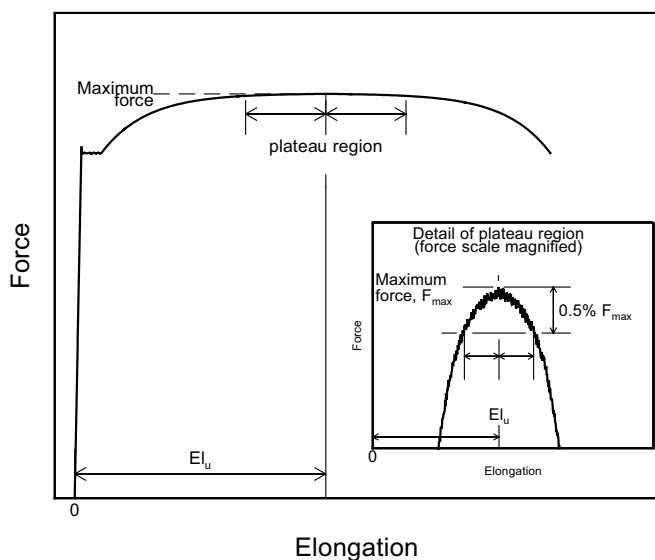

FIG. 25 Stress-Strain Diagram in Which the Upper Yield Strength is the Maximum Stress Recorded Method



**FIG. 26 Force-Elongation Diagram for Determination of Uniform Elongation of Steel Sheet Materials Exhibiting a Plateau at Maximum Force**

- Determine the maximum force recorded (after discontinuous yielding).
- Evaluate the sequence of force values recorded before and after the maximum force.
- Digitally define the “plateau” as consisting of all consecutive data points wherein the force value is within 0.5 % of the magnitude of the peak force value.
- Determine the uniform elongation as the strain at the mid-point of the “plateau.”

**7.9.3.3 Discussion**—The 0.5 % value of **Note 37** has been selected arbitrarily. In actual practice, the value should be selected so as to be the minimum figure that is large enough to effectively define the force plateau. This may require that the percentage be about five times the amplitude of the force fluctuations occurring due to noise. Values ranging from 0.1 % to 1.0 % may be found to work acceptably.

**7.10 Tensile Strength (also known as Ultimate Tensile Strength)**—Calculate the tensile strength by dividing the maximum force carried by the specimen during the tension test by the original cross-sectional area of the specimen.

**NOTE 38**—If the upper yield strength is the maximum stress recorded, and if the stress-strain curve resembles that of **Fig. 25**, it is recommended that the maximum stress after discontinuous yielding be reported as the tensile strength. Where this may occur, determination of the tensile strength should be in accordance with the agreement between the parties involved.

### 7.11 Elongation:

**7.11.1** Elongation may be calculated from elongation-after-fracture measurements or directly from elongation-at-fracture measurements. Either value may be reported, but the method used shall be reported. When disagreements arise over the elongation results, the parties shall agree on which method to use to obtain the results.

**NOTE 39**—Elongation results are very sensitive to variables such as (a) speed of testing, (b) specimen geometry (gauge length, diameter, width, and thickness), (c) heat dissipation (through grips, extensometers, or other devices in contact with the reduced section), (d) surface finish in reduced

section (especially burrs or notches), (e) alignment, and (f) fillets and tapers. Elongation at fracture and elongation after fracture are not interchangeable parameters. Results from the elongation-at-fracture method are generally more repeatable. Parties involved in comparison or conformance testing should standardize the above items. The use of ancillary devices, such as extensometer supports, that may remove heat from the specimen should be avoided. See **Appendix X1** for additional information on the effects of these variables.

### 7.11.2 Measurement of elongation after fracture:

**7.11.2.1** Follow the gauge length marking procedures and requirements of **7.3** and the gauge length tolerance requirements shown in **Fig. 1**, **Fig. 7**, **Fig. 8**, **Fig. 13**, **Fig. 15**, **Fig. 17**, **Fig. 18**, **Fig. 19**, or **Fig. 20** as appropriate. Pay particular attention to requirements for low-elongation materials.

**7.11.2.2** Measure the elongation after fracture by fitting the two halves of the test specimen together and measuring the distance between gauge marks that were applied before the test.

**7.11.2.3** When the specified elongation is greater than 3 %, fit ends of the fractured specimen together carefully and measure the distance between the gauge marks to the nearest 0.25 mm [0.01 in.] for gauge lengths of 50 mm [2 in.] and under, and to at least the nearest 0.5 % of the gauge length for gauge lengths over 50 mm [2 in.]. A percentage scale reading to 0.5 % of the gauge length may be used.

**7.11.2.4** When the specified elongation is 3 % or less, remove partly torn fragments that will interfere with fitting together the ends of the fractured specimen or with making the final measurement. Fit the fractured ends together with matched surfaces and apply a force along the axis of the specimen sufficient to close the fractured ends together. This force may then be removed carefully, provided the specimen remains intact. Measure the final gauge length to the nearest 0.05 mm [0.002 in.], and report the elongation to the nearest 0.2 %. The procedure given in **7.11.2.3** may be used instead when the measured elongation is greater than 3 %.

**NOTE 40**—The use of a force generating a stress of approximately 15 MPa [2000 psi] has been found to give satisfactory results on test specimens of aluminum alloy.

**NOTE 41**—Due to the lack of precision in fitting fractured ends together, the elongation after fracture using the manual methods of the paragraphs **7.11.2** may differ from the elongation at fracture determined with extensometers and described in **7.11.3**.

### 7.11.3 Measurement of elongation at fracture:

**7.11.3.1** Elongation at fracture shall include elastic and plastic elongation.

**NOTE 42**—Unless the specimen has not necked at the point of fracture, correction for elastic strains requires knowledge of the variable strain distribution along the specimen length between the extensometer attachment points, which is beyond the scope of this standard.

**7.11.3.2** Elongation at fracture may be determined with autographic or automated methods using extensometers verified over the strain range of interest (see **5.4.1**). Use a class B2 or better extensometer for materials having less than 5 % elongation, a class C or better extensometer for materials having elongation greater than or equal to 5 % but less than 50 %, and a class D or better extensometer for materials having 50 % or greater elongation. In all cases, the extensometer gauge length shall be the nominal gauge length,  $G$ , required for the specimen being tested.

7.11.3.3 For materials that fail suddenly, the elongation at fracture shall be taken as the strain just prior to the sudden decrease in force.

7.11.3.4 For materials that do not exhibit a sudden decrease in force, the elongation at fracture shall be taken as the strain measured just prior to when the force falls below 10 % of the maximum force encountered during the test.

#### 7.11.4 *Replacement of specimens:*

7.11.4.1 Elongation at or after fracture may be affected by location of the fracture, relative to the marked or extensometer-defined gauge length. If any part of the fracture occurs outside this gauge length (7.14.5) or is located less than 25 % of the elongated gauge length (7.14.6) from either gauge mark or extensometer-contact point, the elongation value may be abnormally low and unrepresentative of the material. If such an elongation measure is not obtained in acceptance testing involving only a minimum requirement and the value meets the requirement, no further testing need be done. Otherwise, discard the test and test a replacement specimen.

#### 7.11.5 *Reporting:*

7.11.5.1 Report both the original gauge length,  $G$ , and the percentage increase.

Example: Elongation = 30% increase (50-mm [2-in.] gauge length)  
(5)

7.11.5.2 If any device other than an extensometer is placed in contact with the specimen's reduced section during the test, report this also.

#### 7.12 *Reduction of Area:*

7.12.1 The reduced area used to calculate reduction of area (see 7.11.2 and 7.11.3) shall be the minimum cross section at the location of fracture.

7.12.2 *Specimens with Originally Circular Cross Sections*—Fit the ends of the fractured specimen together and measure the reduced diameter to the same accuracy as the original measurement.

NOTE 43—Because of anisotropy, circular cross sections often do not remain circular during straining in tension. The shape is usually elliptical, thus, the area may be calculated by  $\pi \cdot d_1 \cdot d_2 / 4$ , where  $d_1$  and  $d_2$  are the major and minor diameters, respectively.

7.12.3 *Specimens with Original Rectangular Cross Sections*—Fit the ends of the fractured specimen together and measure the thickness and width at the minimum cross section to the same accuracy as the original measurements.

NOTE 44—Because of the constraint to deformation that occurs at the corners of rectangular specimens, the dimensions at the center of the original flat surfaces are less than those at the corners. The shapes of these surfaces are often assumed to be parabolic. When this assumption is made, an effective thickness,  $t_e$ , may be calculated as follows:  $(t_1 + 4t_2 + t_3)/6$ , where  $t_1$  and  $t_3$  are the thicknesses at the corners, and  $t_2$  is the thickness at mid-width. An effective width may be similarly calculated.

7.12.4 Calculate the reduced area based upon the dimensions determined in 7.12.2 or 7.12.3. The difference between the area thus found and the area of the original cross section expressed as a percentage of the original area is the reduction of area.

7.12.5 If any part of the fracture takes place outside the middle half of the reduced section or in a punched or scribed

gauge mark within the reduced section, the reduction of area value obtained may not be representative of the material. In acceptance testing, if the reduction of area so calculated meets the minimum requirements specified, no further testing is required, but if the reduction of area is less than the minimum requirements, discard the test results and retest.

7.12.6 Results of measurements of reduction of area shall be rounded using the procedures of Practice E29 and any specific procedures in the product specifications. In the absence of a specified procedure, it is recommended that reduction of area test values in the range from 0 to 10 % be rounded to the nearest 0.5 % and test values of 10 % and greater to the nearest 1 %.

7.13 *Rounding Reported Test Data for Yield Strength and Tensile Strength*—Test data should be rounded using the procedures of Practice E29 and the specific procedures in the product specifications. In the absence of a specified procedure for rounding the test data, one of the procedures described in the following paragraphs is recommended.

7.13.1 For test values up to 500 MPa [50 000 psi], round to the nearest 1 MPa [100 psi]; for test values of 500 MPa [50 000 psi] and up to 1000 MPa [100 000 psi], round to the nearest 5 MPa [500 psi]; for test values of 1000 MPa [100 000 psi] and greater, round to the nearest 10 MPa [1000 psi].

NOTE 45—For steel products, see Test Methods and Definitions A370.

7.13.2 For all test values, round to the nearest 1 MPa [100 psi].

NOTE 46—For aluminum- and magnesium-alloy products, see Methods B557.

7.13.3 For all test values, round to the nearest 5 MPa [500 psi].

7.14 *Replacement of Specimens*—A test specimen may be discarded and a replacement specimen selected from the same lot of material in the following cases:

7.14.1 The original specimen had a poorly machined surface,

7.14.2 The original specimen had the wrong dimensions,

7.14.3 The specimen's properties were changed because of poor machining practice,

7.14.4 The test procedure was incorrect,

7.14.5 The fracture was outside the gauge length,

7.14.6 For elongation determinations, the fracture was outside the middle half of the gauge length, or

7.14.7 There was a malfunction of the testing equipment.

NOTE 47—The tension specimen is inappropriate for assessing some types of imperfections in a material. Other methods and specimens employing ultrasonics, dye penetrants, radiography, etc., may be considered when flaws such as cracks, flakes, porosity, etc., are revealed during a test and soundness is a condition of acceptance.

## 8. Report

8.1 Test information on materials not covered by a product specification should be reported in accordance with 8.2 or both 8.2 and 8.3.

8.2 Test information to be reported shall include the following when applicable:

8.2.1 Reference to the standard used, i.e. E8 or E8M.

Coefficient of Variation, %

	Tensile Strength	Yield Strength Offset = 0.02 %	Yield Strength Offset = 0.2 %	Elongation Gauge Length = 4 Diameter	Reduction of Area
CV % <sub>r</sub>	0.9	2.7	1.4	2.8	2.8
CV % <sub>R</sub>	1.3	4.5	2.3	5.4	4.6

CV %<sub>r</sub> = repeatability coefficient of variation in percent within a laboratory  
 CV %<sub>R</sub> = repeatability coefficient of variation in percent between laboratories

9.1.1 The values shown are the averages from tests on six frequently tested metals, selected to include most of the normal range for each property listed above. When these materials are compared, a large difference in coefficient of variation is found. Therefore, the values above should not be used to judge whether the difference between duplicate tests of a specific material is larger than expected. The values are provided to allow potential users of this test method to assess, in general terms, its usefulness for a proposed application.

9.2 *Bias*—The procedures in Test Methods E8/E8M for measuring tensile properties have no bias because these properties can be defined only in terms of a test method.

## 10. Keywords

10.1 accuracy; bending stress; discontinuous yielding; drop-of-the-beam; eccentric force application; elastic extension; elongation; extension-under-load; extensometer; force; free-running crosshead speed; gauge length; halt-of-the force; percent elongation; plastic extension; preload; rate of stressing; rate of straining; reduced section; reduction of area; sensitivity; strain; stress; taring; tensile strength; tension testing; yield point elongation; yield strength

- 8.2.2 Material and sample identification.
- 8.2.3 Specimen type (see Section 6).
- 8.2.4 Yield strength and the method used to determine yield strength (see 7.7).
- 8.2.5 Yield point elongation (see 7.8).
- 8.2.6 Tensile Strength (also known as Ultimate Tensile Strength) (see 7.10).
- 8.2.7 Elongation (report original gauge length, percentage increase, and method used to determine elongation; i.e. at fracture or after fracture) (see 7.11).
- 8.2.8 Uniform Elongation, if required (see 7.9).
- 8.2.9 Reduction of area, if required (see 7.12).
- 8.3 Test information to be available on request shall include:
  - 8.3.1 Specimen test section dimension(s).
  - 8.3.2 Equation used to calculate cross-sectional area of rectangular specimens taken from large-diameter tubular products.
  - 8.3.3 Speed and method used to determine speed of testing (see 7.6).
  - 8.3.4 Method used for rounding of test results (see 7.13).
  - 8.3.5 Reasons for replacement specimens (see 7.14).

## 9. Precision and Bias

9.1 *Precision*—An interlaboratory test program<sup>3</sup> gave the following values for coefficients of variation for the most commonly measured tensile properties:

<sup>3</sup> Supporting data can be found in [Appendix X1](#) and additional data are available from ASTM Headquarters. Request RR:E28-1004.

## APPENDIXES

### (Nonmandatory Information)

#### X1. FACTORS AFFECTING TENSION TEST RESULTS

X1.1 The precision and bias of tension test strength and ductility measurements depend on strict adherence to the stated test procedure and are influenced by instrumental and material factors, specimen preparation, and measurement/testing errors.

X1.2 The consistency of agreement for repeated tests of the same material is dependent on the homogeneity of the material, and the repeatability of specimen preparation, test conditions, and measurements of the tension test parameters.

X1.3 Instrumental factors that can affect test results include: the stiffness, damping capacity, natural frequency, and mass of moving parts of the tensile test machine; accuracy of force indication and use of forces within the verified range of the machine; rate of force application, alignment of the test specimen with the applied force, parallelness of the grips, grip pressure, nature of the force control used, appropriateness and calibration of extensometers, heat dissipation (by grips, extensometers, or ancillary devices), and so forth.

X1.4 Material factors that can affect test results include: representativeness and homogeneity of the test material, sampling scheme, and specimen preparation (surface finish, dimensional accuracy, fillets at the ends of the gauge length, taper in the gauge length, bent specimens, thread quality, and so forth).

X1.4.1 Some materials are very sensitive to the quality of the surface finish of the test specimen (see [Note 4](#)) and must be ground to a fine finish, or polished to obtain correct results.

X1.4.2 Test results for specimens with as-cast, as-rolled, as-forged, or other non-machined surface conditions can be affected by the nature of the surface (see [Note 10](#)).

X1.4.3 Test specimens taken from appendages to the part or component, such as prolongs or risers, or from separately produced castings (for example, keel blocks) may produce test results that are not representative of the part or component.

X1.4.4 Test specimen dimensions can influence test results. For cylindrical or rectangular specimens, changing the test

specimen size generally has a negligible effect on the yield and tensile strength but may influence the upper yield strength, if one is present, and elongation and reduction of area values. Comparison of elongation values determined using different specimens requires that the following ratio be controlled:

$$L_o/(A_o)^{1/2} \quad (X1.1)$$

where:

$L_o$  = original gauge length of specimen, and  
 $A_o$  = original cross-sectional area of specimen.

X1.4.4.1 Specimens with smaller  $L_o/(A_o)^{1/2}$  ratios generally give greater elongation and reduction in area values. This is the case for example, when the width or thickness of a rectangular tensile test specimen is increased.

X1.4.4.2 Holding the  $L_o/(A_o)^{1/2}$  ratio constant minimizes, but does not necessarily eliminate, differences. Depending on material and test conditions, increasing the size of the proportional specimen of Fig. 8 may be found to increase or decrease elongation and reduction in area values somewhat.

X1.4.5 Use of a taper in the gauge length, up to the allowed 1 % limit, can result in lower elongation values. Reductions of as much as 15 % have been reported for a 1 % taper.

X1.4.6 Changes in the strain rate can affect the yield strength, tensile strength, and elongation values, especially for materials which are highly strain rate sensitive. In general, the yield strength and tensile strength will increase with increasing strain rate, although the effect on tensile strength is generally less pronounced. Elongation values generally decrease as the strain rate increases.

X1.4.7 Brittle materials require careful specimen preparation, high quality surface finishes, large fillets at the ends of the gauge length, oversize threaded grip sections, and cannot tolerate punch or scribe marks as gauge length indicators.

X1.4.8 Flattening of tubular products to permit testing does alter the material properties, generally nonuniformly, in the flattened region which may affect test results.

X1.5 Measurement errors that can affect test results include: verification of the test force, extensometers, micrometers, dividers, and other measurement devices, alignment and zero-

ing of chart recording devices, and so forth.

X1.5.1 Measurement of the dimensions of as-cast, as-rolled, as-forged, and other test specimens with non-machined surfaces may be imprecise due to the irregularity of the surface flatness.

X1.5.2 Materials with anisotropic flow characteristics may exhibit non-circular cross sections after fracture and measurement precision may be affected, as a result (see Note 38).

X1.5.3 The corners of rectangular test specimens are subject to constraint during deformation and the originally flat surfaces may be parabolic in shape after testing which will affect the precision of final cross-sectional area measurements (see Note 44).

X1.5.4 If any portion of the fracture occurs outside of the middle of the gauge length, or in a punch or scribe mark within the gauge length, the elongation and reduction of area values may not be representative of the material. Wire specimens that break at or within the grips may not produce test results representative of the material.

X1.5.5 Use of specimens with shouldered ends (“button-head” tensiles) will produce lower 0.02 % offset yield strength values than threaded specimens.

X1.6 Because standard reference materials with certified tensile property values are not available, it is not possible to rigorously define the bias of tension tests. However, by the use of carefully designed and controlled interlaboratory studies, a reasonable definition of the precision of tension test results can be obtained.

X1.6.1 An interlaboratory test program<sup>3</sup> was conducted in which six specimens each, of six different materials were prepared and tested by each of six different laboratories. Tables X1.1-X1.6 present the precision statistics, as defined in Practice E691, for: tensile strength, 0.02 % yield strength, 0.2 % yield strength, % elongation in 4D, % elongation in 5D, and % reduction in area. In each table, the first column lists the six materials tested, the second column lists the average of the average results obtained by the laboratories, the third and fifth columns list the repeatability and reproducibility standard deviations, the fourth and sixth columns list the coefficients of

**TABLE X1.1 Precision Statistics—Tensile Strength, MPa [ksi]**

NOTE 1— $X$  is the average of the cell averages, that is, the grand mean for the test parameter,  
 $s_r$  is the repeatability standard deviation (within-laboratory precision) in MPa [ksi],  
 $s_r/X$  is the coefficient of variation in %,  
 $s_R$  is the reproducibility standard deviation (between-laboratory precision) in MPa [ksi],  
 $s_R/X$  is the coefficient of variation, %,   
 $r$  is the 95 % repeatability limits in MPa [ksi],  
 $R$  is the 95 % reproducibility limits in MPa [ksi].

Material	$X$	$s_r$	$s_r/X, \%$	$s_R$	$s_R/X, \%$	$r$	$R$
EC-H19	176.9 [25.66]	4.3 [0.63]	2.45	4.3 [0.63]	2.45	12.1 [1.76]	12.1 [1.76]
2024-T351	491.3 [71.26]	6.1 [0.88]	1.24	6.6 [0.96]	1.34	17.0 [2.47]	18.5 [2.68]
ASTM A105	596.9 [86.57]	4.1 [0.60]	0.69	8.7 [1.27]	1.47	11.6 [1.68]	24.5 [3.55]
AISI 316	694.6 [100.75]	2.7 [0.39]	0.39	8.4 [1.22]	1.21	7.5 [1.09]	23.4 [3.39]
Inconel 600	685.9 [99.48]	2.9 [0.42]	0.43	5.0 [0.72]	0.72	8.2 [1.19]	13.9 [2.02]
SAE 51410	1253.0 [181.73]	0.25 [0.46]	0.25	7.9 [1.14]	0.63	8.9 [1.29]	22.1 [ 3.20]
		Averages:	0.91		1.30		

**TABLE X1.2 Precision Statistics—0.02 % Yield Strength, MPa [ksi]**

Material	$X$	$s_r$	$s_r/X, \%$	$s_R$	$s_R/X, \%$	$r$	$R$
EC-H19	111.4 [16.16]	4.5 [0.65]	4.00	8.2 [1.19]	7.37	12.5 [1.81]	23.0 [3.33]
2024-T351	354.2 [51.38]	5.8 [0.84]	1.64	6.1 [0.89]	1.73	16.3 [2.36]	17.2 [2.49]
ASTM A105	411.1 [59.66]	8.3 [1.20]	2.02	13.1 [1.90]	3.18	23.2 [3.37]	36.6 [5.31]
AISI 316	336.1 [48.75]	16.7 [2.42]	4.97	31.9 [4.63]	9.49	46.1 [6.68]	89.0 [12.91]
Inconel 600	267.1 [38.74]	3.2 [0.46]	1.18	5.2 [0.76]	1.96	8.8 [1.28]	14.7 [2.13]
SAE 51410	723.2 [104.90]	16.6 [2.40]	2.29	21.9 [3.17]	3.02	46.4 [6.73]	61.2 [8.88]
		Averages:	2.68		4.46		

**TABLE X1.3 Precision Statistics—0.2 % Yield Strength, MPa [ksi]**

Material	$X$	$s_r$	$s_r/X, \%$	$s_R$	$s_R/X, \%$	$r$	$R$
EC-H19	158.4 [22.98]	3.3 [0.47]	2.06	3.3 [0.48]	2.07	9.2 [1.33]	9.2 [1.33]
2024-T351	362.9 [52.64]	5.1 [0.74]	1.41	5.4 [0.79]	1.49	14.3 [2.08]	15.2 [2.20]
ASTM A105	402.4 [58.36]	5.7 [0.83]	1.42	9.9 [1.44]	2.47	15.9 [2.31]	27.8 [4.03]
AISI 316	481.1 [69.78]	6.6 [0.95]	1.36	19.5 [2.83]	4.06	18.1 [2.63]	54.7 [7.93]
Inconel 600	268.3 [38.91]	2.5 [0.36]	0.93	5.8 [0.85]	2.17	7.0 [1.01]	16.3 [2.37]
SAE 51410	967.5 [140.33]	8.9 [1.29]	0.92	15.9 [2.30]	1.64	24.8 [3.60]	44.5 [6.45]
		Averages:	1.35		2.32		

**TABLE X1.4 Precision Statistics—% Elongation in 4D for E8 Specimens**

NOTE 1—Length of reduced section = 6D.

Material	$X$	$s_r$	$s_r/X, \%$	$s_R$	$s_R/X, \%$	$r$	$R$
EC-H19	17.42	0.64	3.69	0.92	5.30	1.80	2.59
2024-T351	19.76	0.58	2.94	1.58	7.99	1.65	4.43
ASTM A105	29.10	0.76	2.62	0.98	3.38	2.13	2.76
AISI 316	40.07	1.10	2.75	2.14	5.35	3.09	6.00
Inconel 600	44.28	0.66	1.50	1.54	3.48	1.86	4.31
SAE 51410	14.48	0.48	3.29	0.99	6.83	1.34	2.77
		Averages:	2.80		5.39		

**TABLE X1.5 Precision Statistics—% Elongation in 5D for E8M Specimens**

NOTE 1—Length of reduced section = 6D.

Material	$X$	$s_r$	$s_r/X, \%$	$s_R$	$s_R/X, \%$	$r$	$R$
EC-H19	14.60	0.59	4.07	0.66	4.54	1.65	1.85
2024-T351	17.99	0.63	3.48	1.71	9.51	1.81	4.81
ASTM A105	25.63	0.77	2.99	1.30	5.06	2.15	3.63
AISI 316	35.93	0.71	1.98	2.68	7.45	2.00	7.49
Inconel 600	41.58	0.67	1.61	1.60	3.86	1.88	4.49
SAE 51410	13.39	0.45	3.61	0.96	7.75	1.25	2.89
		Averages:	2.96		6.36		

**TABLE X1.6 Precision Statistics—% Reduction in Area**

Material	$X$	$s_r$	$s_r/X, \%$	$s_R$	$s_R/X, \%$	$r$	$R$
EC-H19	79.15	1.93	2.43	2.01	2.54	5.44	5.67
2024-T351	30.41	2.09	6.87	3.59	11.79	5.79	10.01
ASTM A105	65.59	0.84	1.28	1.26	1.92	2.35	3.53
AISI 316	71.49	0.99	1.39	1.60	2.25	2.78	4.50
Inconel 600	59.34	0.67	1.14	0.70	1.18	1.89	1.97
SAE 51410	50.49	1.86	3.69	3.95	7.81	5.21	11.05
		Averages:	2.80		4.58		

variation for these standard deviations, and the seventh and eighth columns list the 95 % repeatability and reproducibility limits.

X1.6.2 The averages (below columns four and six in each table) of the coefficients of variation permit a relative comparison of the repeatability (within-laboratory precision) and reproducibility (between-laboratory precision) of the tension

test parameters. This shows that the ductility measurements exhibit less repeatability and reproducibility than the strength measurements. The overall ranking from the least to the most repeatable and reproducible is: % elongation in 4D, % elongation in 5D, % reduction in area, 0.02 % offset yield strength, 0.2 % offset yield strength, and tensile strength. Note that the rankings are in the same order for the repeatability and

reproducibility average coefficients of variation and that the reproducibility (between-laboratory precision) is poorer than the repeatability (within-laboratory precision) as would be expected.

X1.6.3 No comments about bias can be made for the interlaboratory study due to the lack of certified test results for

these specimens. However, examination of the test results showed that one laboratory consistently exhibited higher than average strength values and lower than average ductility values for most of the specimens. One other laboratory had consistently lower than average tensile strength results for all specimens.

## X2. MEASUREMENT OF SPECIMEN DIMENSIONS

X2.1 Measurement of specimen dimensions is critical in tension testing, and it becomes more critical with decreasing specimen size, as a given absolute error becomes a larger relative (percent) error. Measuring devices and procedures should be selected carefully, so as to minimize measurement error and provide good repeatability and reproducibility.

X2.2 Relative measurement error should be kept at or below 1 %, where possible. Ideally, this 1 % error should include not only the resolution of the measuring device but also the variability commonly referred to as repeatability and reproducibility. (Repeatability is the ability of any operator to obtain similar measurements in repeated trials. Reproducibility is the ability of multiple operators to obtain similar measurements.)

X2.3 Formal evaluation of gage repeatability and reproducibility (GR and R) by way of a GR and R study is highly recommended. A GR and R study involves having multiple operators each take two or three measurements of a number of parts—in this case, test specimens. Analysis, usually done by computer, involves comparing the observed measurement variations to a tolerance the procedure is to determine conformance to. High GR and R percentages (more than 20 %) indicate much variability relative to the tolerance, whereas low percentages (10 % or lower) indicate the opposite. The analysis also estimates, independently, the repeatability and reproducibility.

X2.4 GR and R studies in which nontechnical personnel used different brands and models of hand-held micrometers have given results varying from about 10 % (excellent) to nearly 100 % (essentially useless), relative to a dimensional tolerance of 0.075 mm [0.003 in.]. The user is therefore advised to be very careful in selecting devices, setting up measurement procedures, and training personnel.

X2.5 With a 0.075 mm [0.003 in.] tolerance, a 10 % GR and R result (exceptionally good, even for digital hand-held micrometers reading to 0.001 mm [0.00005 in.]) indicates that the total variation due to repeatability and reproducibility is around 0.0075 [0.0003 in.]. This is less than or equal to 1 % only if all dimensions to be measured are greater than or equal to 0.75 mm [0.03 in.]. The relative error in using this device to measure thickness of a 0.25 mm [0.01 in.] flat tensile specimen would be 3 %—which is considerably more than that allowed for force or strain measurement.

X2.6 Dimensional measurement errors can be identified as the cause of many *out-of-control* signals, as indicated by

statistical process control (SPC) charts used to monitor tension testing procedures. This has been the experience of a production laboratory employing SPC methodology and the best hand-held micrometers available (from a GR and R standpoint) in testing of 0.45 to 6.35 mm [0.018 to 0.25 in.] flat rolled steel products.

X2.7 Factors which affect GR and R, sometimes dramatically, and which should be considered in the selection and evaluation of hardware and procedures include:

- X2.7.1 Resolution,
- X2.7.2 Verification,
- X2.7.3 Zeroing,
- X2.7.4 Type of anvil (flat, rounded, or pointed),
- X2.7.5 Cleanliness of part and anvil surfaces,
- X2.7.6 User-friendliness of measuring device,
- X2.7.7 Stability/temperature variations,
- X2.7.8 Coating removal,
- X2.7.9 Operator technique, and
- X2.7.10 Ratchets or other features used to regulate the clamping force.

X2.8 Flat anvils are generally preferred for measuring the dimensions of round or flat specimens which have relatively smooth surfaces. One exception is that rounded or pointed anvils must be used in measuring the thickness of curved specimens taken from large-diameter tubing (see Fig. 13), to prevent overstating the thickness. (Another concern for these curved specimens is the error that can be introduced through use of the equation  $A = W \times T$ ; see 7.2.3.)

X2.9 Heavy coatings should generally be removed from at least one grip end of flat specimens taken from coated products to permit accurate measurement of base metal thickness, assuming (a) the base metal properties are what are desired, (b) the coating does not contribute significantly to the strength of the product, and (c) coating removal can be easily accomplished (some coatings may be easily removed by chemical stripping). Otherwise, it may be advisable to leave the coating intact and determine the base metal thickness by an alternate method. Where this issue may arise, all parties involved in comparison or conformance testing should agree as to whether or not coatings are to be removed before measurement.

X2.10 As an example of how the considerations identified above affect dimensional measurement procedures, consider



the case of measuring the thickness of 0.40 mm [0.015 in.] painted, flat rolled steel specimens. The paint should be removed prior to measurement, if possible. The measurement device used should have flat anvils, must read to 0.0025 mm [0.0001 in.] or better, and must have excellent repeatability and reproducibility. Since GR and R is a significant concern, it will be best to use a device which has a feature for regulating the

clamping force used, and devices without digital displays should be avoided to prevent reading errors. Before use of the device, and periodically during use, the anvils should be cleaned, and the device should be verified or zeroed (if an electronic display is used) or both. Finally, personnel should be trained and audited periodically to ensure that the measuring device is being used correctly and consistently by all.

### **X3. SUGGESTED ACCREDITATION CRITERIA FOR LABORATORIES PERFORMING TENSILE TESTS**

#### **X3.1 Scope**

X3.1.1 The following are specific features that an assessor may check to assess a laboratory's technical competence, if the laboratory is performing tests in accordance with Test Methods E8/E8M.

#### **X3.2 Preparation**

X3.2.1 The laboratory should follow documented procedures to ensure that machining or other preparation generates specimens conforming to applicable tolerances and requirements of Test Methods E8/E8M. Particularly important are those requirements that pertain to the dimensions and finish of reduced sections, as found in the text and in applicable figures.

X3.2.2 Where gauge marks are used, the laboratory should employ documented gauge marking procedures to ensure that the marks and gauge lengths comply with the tolerances and guidelines of Test Methods E8/E8M.

X3.2.2.1 The gauge marking procedure used should not deleteriously affect the test results.

NOTE X3.1—Frequent occurrence of fracturing at the gauge marks may indicate that gauge marks have excessive depth or sharpness and may be affecting test results.

#### **X3.3 Test Equipment**

X3.3.1 As specified in the Apparatus sections of Test Methods E8/E8M, the axis of the test specimen should coincide with the center line of the heads of the testing machine, in order to minimize bending stresses which could affect the results.

X3.3.2 Equipment verification requirements of Practices **E4** and **E83** shall be met. Documentation showing the verification work to have been thorough and technically correct should be available.

X3.3.2.1 Verification reports shall demonstrate that force and extension readings have been taken at the prescribed intervals and that the prescribed runs have been completed.

X3.3.3 Extensometers used shall meet all requirements of Test Methods E8/E8M as to the classification of device to be used for the results determined. For example, an extensometer not meeting the Class B2 requirements of Practice **E83** may not be used in determination of offset yield strengths.

X3.3.4 Before computerized or automated test equipment is put into routine service, or following a software revision, it is recommended that measures be taken to verify proper operation and result interpretation. Guide **E1856** addresses this concern.

X3.3.5 Micrometers and other devices used in measurement of specimen dimensions should be selected, maintained and used in such a manner as to comply with the appendixes of Test Methods E8/E8M on measurement. Traceability to national standards should be established for these devices, and reasonable effort should be employed to prevent errors greater than 1 % from being generated as a result of measurement error, resolution, and rounding practice.

#### **X3.4 Procedures**

X3.4.1 The test machine shall be set up and zeroed in such a manner that zero force indication signifies a state of zero force on the specimen, as indicated in the Zeroing of the Test Machine sections of Test Methods E8/E8M.

NOTE X3.2—Provisions should be made to ensure that zero readings are properly maintained, from test to test. These may include, for example, zeroing after a predetermined number of tests or each time, under zero force conditions, the indicator exceeds a predetermined value.

X3.4.2 Upon request, the laboratory should be capable of demonstrating (perhaps through time, force, displacement or extensometer measurements, or both) that the test speeds used conform to the requirements of Test Methods E8/E8M, or other standards which take precedence.

X3.4.3 Upon request, the laboratory should be capable of demonstrating that the offsets and extensions used in determining yield strengths conform to the requirements of Test Methods E8/E8M and are constructed so as to indicate the forces corresponding to the desired offset strain or total strain.

NOTE X3.3—Use caution when performing calculations with extensometer magnification, because the manufacturer may report strain magnification, which relates the strain (not the elongation) to the x-axis displacement on the stress strain diagram. A user or assessor interested in an extensometer's magnification may use calibration equipment to determine the ratio between elongation and chart travel or may verify a reported magnification by calculating the Young's modulus from tests of specimens of a known nominal modulus.

X3.4.4 Measurement of elongation shall conform to requirements of Test Methods E8/E8M.

NOTE X3.4—Test Methods E8/E8M permit the measurement and reporting of elongation at fracture in place of elongation, as is often done in automated testing.

X3.4.5 Reduction of area, when required, shall be determined in accordance with the requirements of Test Methods E8/E8M.

X3.4.6 Procedures for recording, calculating, and reporting data and test results shall conform to all applicable requirements of Test Methods E8/E8M. In addition, wherever

practical, the procedures should also be in accordance with widely accepted provisions of good laboratory practice, such as those detailed below.

X3.4.6.1 When recording data, personnel should record all figures that are definite, plus the best estimate of the first figure which is uncertain. (If a result is known to be approximately midway between 26 and 27, 26.5 should be the result recorded (not 26, 27, or 26.475).

X3.4.6.2 When performing calculations, personnel should avoid compounding of rounding errors. This may be accomplished by performing one large calculation, rather than several calculations using individual results. Alternatively, if multi-step calculations are done, intermediate results should not be rounded before use in subsequent calculations.

X3.4.6.3 In rounding, no final result should retain more significant figures than the least-significant-figure measurement or data point used in the calculation.

### X3.5 Retention

X3.5.1 A retention program appropriate for the nature and frequency of testing done in the laboratory should be maintained. Items that may warrant retention for defined time periods include:

- X3.5.1.1 Raw data and forms,
- X3.5.1.2 Force-elongation or stress-strain charts,
- X3.5.1.3 Computer printouts of curves and test results,
- X3.5.1.4 Data and results stored on computer discs or hard drives,
- X3.5.1.5 Broken specimens,
- X3.5.1.6 Excess material,
- X3.5.1.7 Test reports, and
- X3.5.1.8 Verification reports and certifications.

### X3.6 Environment

X3.6.1 All test equipment should be located and connected to power sources in such a manner as to minimize the effects

of vibrations and electrical disturbances on raw data collected, stress-strain charts, and operation of equipment.

### X3.7 Controls

X3.7.1 Controlled procedures and work instructions should cover all aspects of specimen preparation, tensile testing, and result reporting. These documents should be readily available to all involved in the documented tasks.

X3.7.2 Clear, concise, operating instructions should be maintained for equipment used in specimen preparation and tensile testing. These instructions should be readily available to all qualified operators.

X3.7.3 All applicable verification requirements shall be met, as detailed in X3.3.2.

X3.7.4 It is recommended that special studies and programs be employed to monitor and control tensile testing, because tensile test results are easily affected by operators, measuring devices, and test equipment. Examples of such programs include but are not limited to:

- X3.7.4.1 Round-robin studies, proficiency tests, or other cross-checks,
- X3.7.4.2 Repeatability and reproducibility (R and R) studies,
- X3.7.4.3 Control charting, and
- X3.7.4.4 Determination of typical lab uncertainties for each result typically reported.

NOTE X3.5—For nondestructive testing, repeatability and reproducibility are often measured by conducting gage R and R studies, as discussed in Appendix X2 of Test Methods E8/E8M. These studies involve repeated determination of a test result, using a single part or specimen, so gage R and Rs are not directly applicable to mechanical properties, which are obtained through destructive testing. (True differences between even the best duplicate specimens manifest themselves in the form of poorer R and R results than would be obtained for perfect duplicates.) Nevertheless, quasi-R and R studies conducted with these limitations taken into consideration may be helpful in analyzing sources of error and improving reliability of test results.

## X4. ADDITIONAL INFORMATION ON SPEED OF TESTING AND EXAMPLES

X4.1 Many materials are strain-rate sensitive that is, the yield strength or tensile strength of the material is a function of the rate at which the material is being deformed. The yield strength of some materials can change by more than ten percent when tested with the slowest and then the highest speeds permitted by Test Methods E8/E8M. In order to reproduce yield test results, for strain-rate sensitive materials, it is important that strain rates during the determination of yield are similar.

X4.2 The following paragraphs further explain the various Control Methods required to be used by Test Methods E8/E8M when other guidance is not given. When other test speed requirements are specified, those speeds must be followed to comply with this test method. For example, aerospace specifications often require a test speed when determining yield strength to be a strain rate equal to  $0.005 \pm 0.002$  mm/mm/min [in./in./min]; when specified, that speed must be followed in

order to comply with this standard.

X4.2.1 *Control Method A - Rate of Stressing Method for Determining Yield Properties* – This method has been the default method of control in Test Methods E8/E8M for many years. In this method, the crosshead speed of the machine is adjusted during the linear elastic portion of the curve to achieve the desired stress rate (or the speed is set to a predetermined value known to achieve the desired stress rate). The crosshead speed is not adjusted when the material begins to yield. The advantage of this control method is that it does not require any transducers other than the load indicator itself, although, load pacers and stress-rate indicators can be helpful. This method of control has a limitation in that the strain rate of the specimen at yield depends on the slope of the stress-strain curve (tangent modulus) and the testing machine stiffness. Because of this, the strain rate of the specimen when yield is determined can be different for different specimen sizes, different specimen

configurations, different gripping configurations, and different testing machines. This difference in strain rate can affect the reproducibility of yield strength in strain-rate-sensitive materials.

X4.2.1.1 It is not the intent of this method to run the testing machine in closed-loop force control, because as the material begins to yield the testing machine will speed up, possibly to its maximum speed. However, using closed-loop force control during the elastic region of the test and switching to an equivalent crosshead speed prior to yield is an acceptable method.

X4.2.2 *Control Method B —Rate of Straining Control Method for Determining Yield Properties* - This method is usually performed with a testing machine that has a closed-loop control system that uses feedback from an extensometer to automatically adjust the speed of the testing machine. However, some skilled operators can monitor a strain rate indicator attached to the extensometer and adjust the speed of the testing machine manually to maintain the required strain rate test speed. To maintain constant strain rate control during a test, the crosshead speed of the testing machine must slow down drastically when the specimen begins to yield. This method has three advantages. (1) The time to achieve yield results is short (about 20 to 40 s). (2) The reproducibility of yield strength test results from machine to machine and laboratory to laboratory is good. (3) The agreement with the results of Control Method C is good, because the strain rates are similar when the specimen's yield strength is determined. This method has three disadvantages. (1) The testing equipment is generally more expensive. (2) Proper control and safety depend on the control parameters to be properly set and that the extensometer integrity be maintained (accidental slippage of the extensometer can result in unexpected movement of the

crosshead). Proper safety limits must be set to ensure safety of personnel and equipment. (3) When materials have yield points or yield discontinuously, a machine under closed-loop strain-rate control can behave erratically. This control method is not recommended for materials that yield discontinuously.

X4.2.3 *Control Method C - Crosshead Speed Control Method for Determining Yield Properties*—This method can be performed on any testing machine that has reasonably good crosshead speed control. This method has three advantages. (1) The reproducibility from machine to machine and laboratory to laboratory is good. (2) The agreement with Control Method B is good, because the strain rates are similar when the specimen's yield strength is determined. (3) This method of controlling a testing machine is excellent for materials that yield discontinuously. The disadvantage of this method of control is that the test time to yield can be more than three minutes, depending on the material being tested and the compliance of the testing machine including its grip assemblies.

X4.2.3.1 *An example using SI metric units of how to apply Control Method C* to testing Specimen 1 in Fig. 13 is as follows. The length of the reduced section, that is, dimension A in Fig. 13, is equal to 60 mm. The crosshead speed is determined per Control Method C by multiplying 60 mm by 0.015 mm/mm/min to arrive at a crosshead speed of 0.9 mm/min.

X4.2.3.2 *An example using U.S. customary units of how to apply Control Method C* to testing Specimen 1 in Fig. 13 is as follows. The length of the reduced section, that is, dimension A in Fig. 13 is equal to 2.25 in. The crosshead speed is determined per Control Method C by multiplying 2.25 in. by 0.015 in./in./min to arrive at a crosshead speed of 0.034 in./min.

## 5. CALCULATING THE YIELD STRENGTH WHEN THE STRESS-STRAIN CURVE DEVIATES FROM IDEAL BEHAVIOR

X5.1 In many cases, the stress-strain diagram deviates from the ideal behavior that Fig. 21 illustrates. To compute the yield strength by the offset method (7.7.1) or the extension-under-load method (7.7.2), these deviations should be analyzed appropriately.

X5.2 Fig. X5.1 illustrates a schematic stress-strain diagram with idealized behavior and five types of deviation from ideal behavior. This appendix suggests methods for computing the offset and extension-under-load yield strengths when these deviations occur.

X5.3 Fig. X5.1a shows the ideal behavior. The line *OA*, superimposed on the straight-line portion of the stress-strain curve, intersects the origin, *O*, of the stress-strain diagram. For the offset method, the line *mn* is parallel to *OA* at a distance *X* from the intersection of *OA* with the strain axis. For the extension-under-load method, the line *pq* extends vertically from the strain axis at a distance *Y* from the intersection of *OA* with the strain axis.

X5.4 Fig. X5.1b illustrates behavior that can occur if the

extensometer is displaced slightly to negative strains when it is attached to the specimen.

X5.5 Fig. X5.1c illustrates behavior that can occur if the extensometer slips on the specimen when the force is applied.

X5.6 Fig. X5.1d illustrates the behavior that can occur when the specimen straightens as the force is applied, due to misalignment or residual stress.

X5.7 Fig. X5.1e illustrates the behavior that can occur if the specimen slips in the grips and disturbs the extensometer as the force is applied.

X5.8 Fig. X5.1f illustrates the behavior that sometimes occurs in bent specimens or specimens with coil set.

X5.9 In all five non-ideal cases, the straight-line portion of the stress-strain curve no longer intersects the origin, *O*, of the stress-strain diagram. Instead, the line *O'A* intersects the strain axis at a point *O'*. In the offset method, the line *mn* is parallel to *O'A* at a distance *X* from the point *O'*, the intersection of the

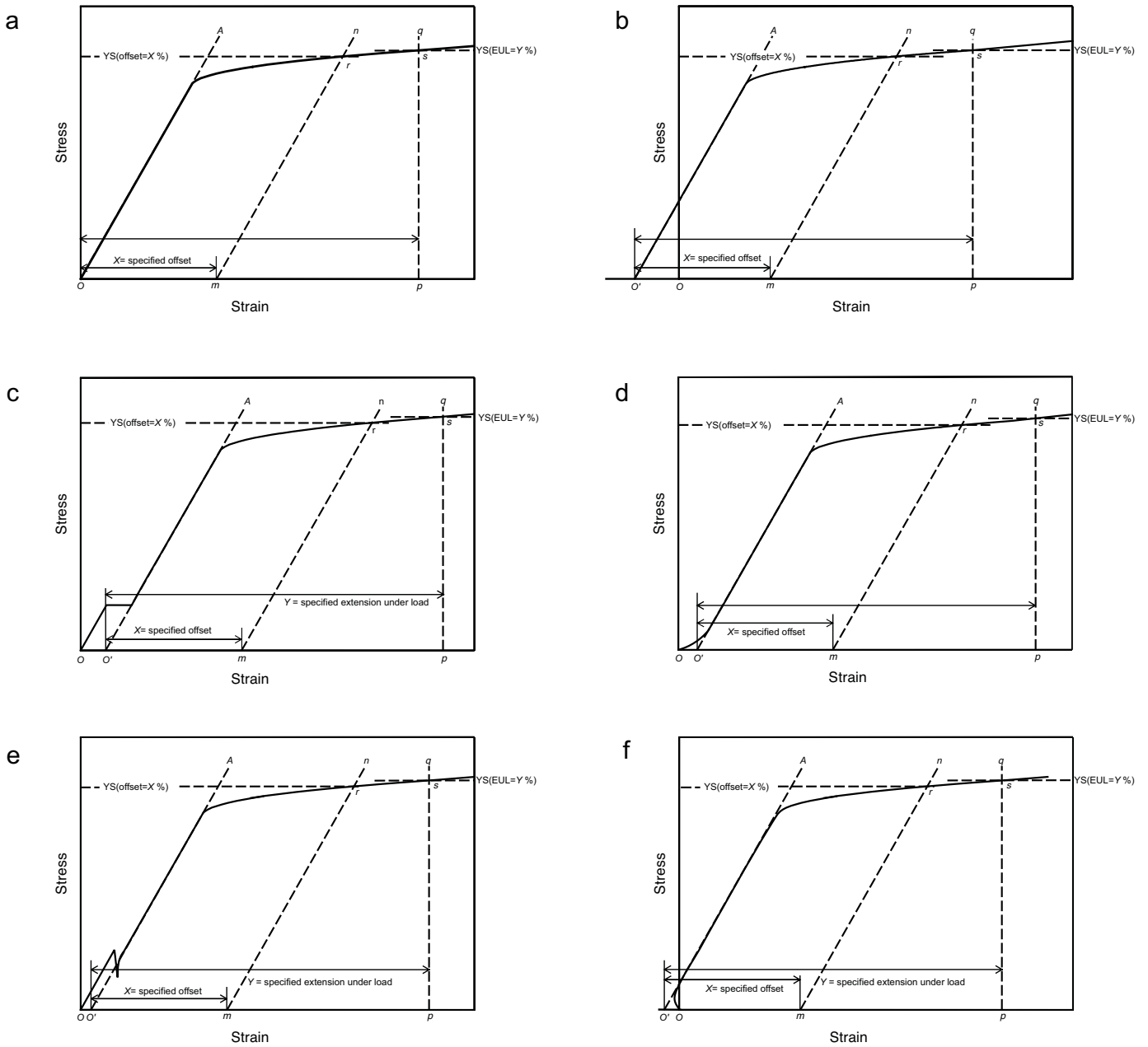

FIG. X5.1 Schematic Stress-strain Diagram

elastic loading line,  $O'A$ , with the strain axis. In the extension-under-load method, the line  $pq$  extends vertically from the strain axis at a distance  $Y$  from the point  $O'$ .

**SUMMARY OF CHANGES**

Committee E28 has identified the location of selected changes to this standard since the last issue (E8/E8M-15) that may impact the use of this standard. (Approved May 15, 2015.)

- (1) **Appendix X5** was added.
- (2) **7.7** was revised.
- (3) Figure 22 from E8/E8M-15 was combined with **Fig. 21**.

Committee E28 has identified the location of selected changes to this standard since the last issue (E8/E8M-13a) that may impact the use of this standard. (Approved February 1, 2015.)

- (1) **7.11** was revised.

Committee E28 has identified the location of selected changes to this standard since the last issue (E8/E8M-13) that may impact the use of this standard. (Approved July 1, 2013.)

- (1) **3.1.4** was revised.
- (2) **3.1.5** was added.

Committee E28 has identified the location of selected changes to this standard since the last issue (E8/E8M-11) that may impact the use of this standard. (Approved June. 1, 2013.)

- (1) Replaced 3.1.
- (2) Added **3.1.2**.
- (3) Reformatted **3.1.3**.
- (4) Reformatted **3.1.4**.
- (5) Added **3.1.7, 3.1.8, and 3.1.12**.
- (6) Reformatted **3.1.11**.
- (7) Added **3.2.1**.
- (8) Added **Note 33**.

*ASTM International takes no position respecting the validity of any patent rights asserted in connection with any item mentioned in this standard. Users of this standard are expressly advised that determination of the validity of any such patent rights, and the risk of infringement of such rights, are entirely their own responsibility.*

*This standard is subject to revision at any time by the responsible technical committee and must be reviewed every five years and if not revised, either reapproved or withdrawn. Your comments are invited either for revision of this standard or for additional standards and should be addressed to ASTM International Headquarters. Your comments will receive careful consideration at a meeting of the responsible technical committee, which you may attend. If you feel that your comments have not received a fair hearing you should make your views known to the ASTM Committee on Standards, at the address shown below.*

*This standard is copyrighted by ASTM International, 100 Barr Harbor Drive, PO Box C700, West Conshohocken, PA 19428-2959, United States. Individual reprints (single or multiple copies) of this standard may be obtained by contacting ASTM at the above address or at 610-832-9585 (phone), 610-832-9555 (fax), or service@astm.org (e-mail); or through the ASTM website (www.astm.org). Permission rights to photocopy the standard may also be secured from the Copyright Clearance Center, 222 Rosewood Drive, Danvers, MA 01923, Tel: (978) 646-2600; <http://www.copyright.com/>*